

SCHEDULE				
PCE	QTY	MTRL	DESCRIPTION	LENGTH
A	1	C89x38x1.0	STUD	2398
B	1	C89x38x1.0	BOTTOM TRACK	1000
C	1	C89x38x1.0	NOGGIN	998
D	1	C89x38x1.0	STUD	2398
E	1	C89x38x1.0	TOP TRACK	1000
F	1	C89x38x1.0	STUD	2398
Total Length: 10192.00mm				

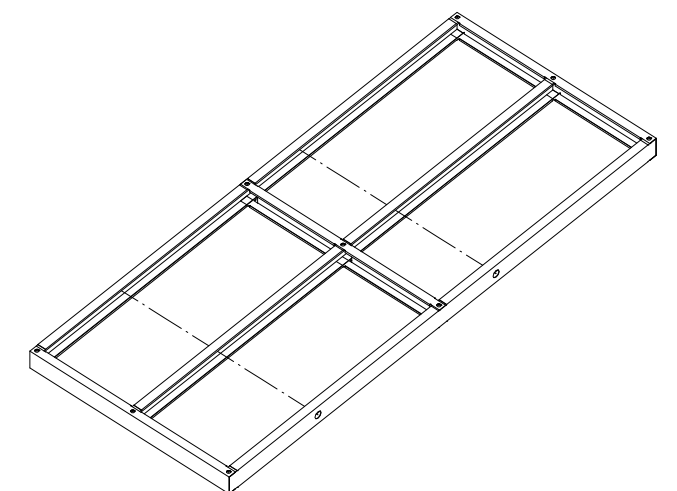

SCHEDULE				
PCE	QTY	MTRL	DESCRIPTION	LENGTH
A	1	C89x38x0.8	STUD	2398
B	1	C89x38x0.8	BOTTOM TRACK	1000
C	1	C89x38x0.8	NOGGIN	998
D	1	C89x38x0.8	STUD	2398
E	1	C89x38x0.8	TOP TRACK	1000
F	1	C89x38x0.8	STUD	2398
Total Length: 10192.00mm				

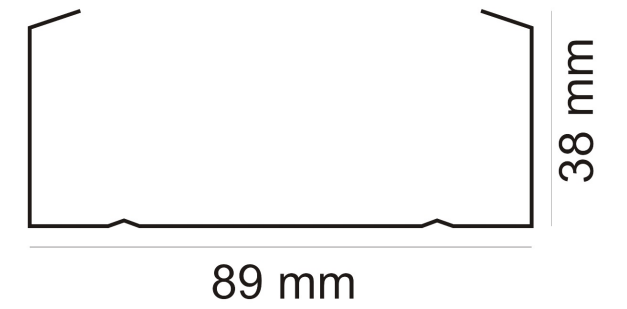
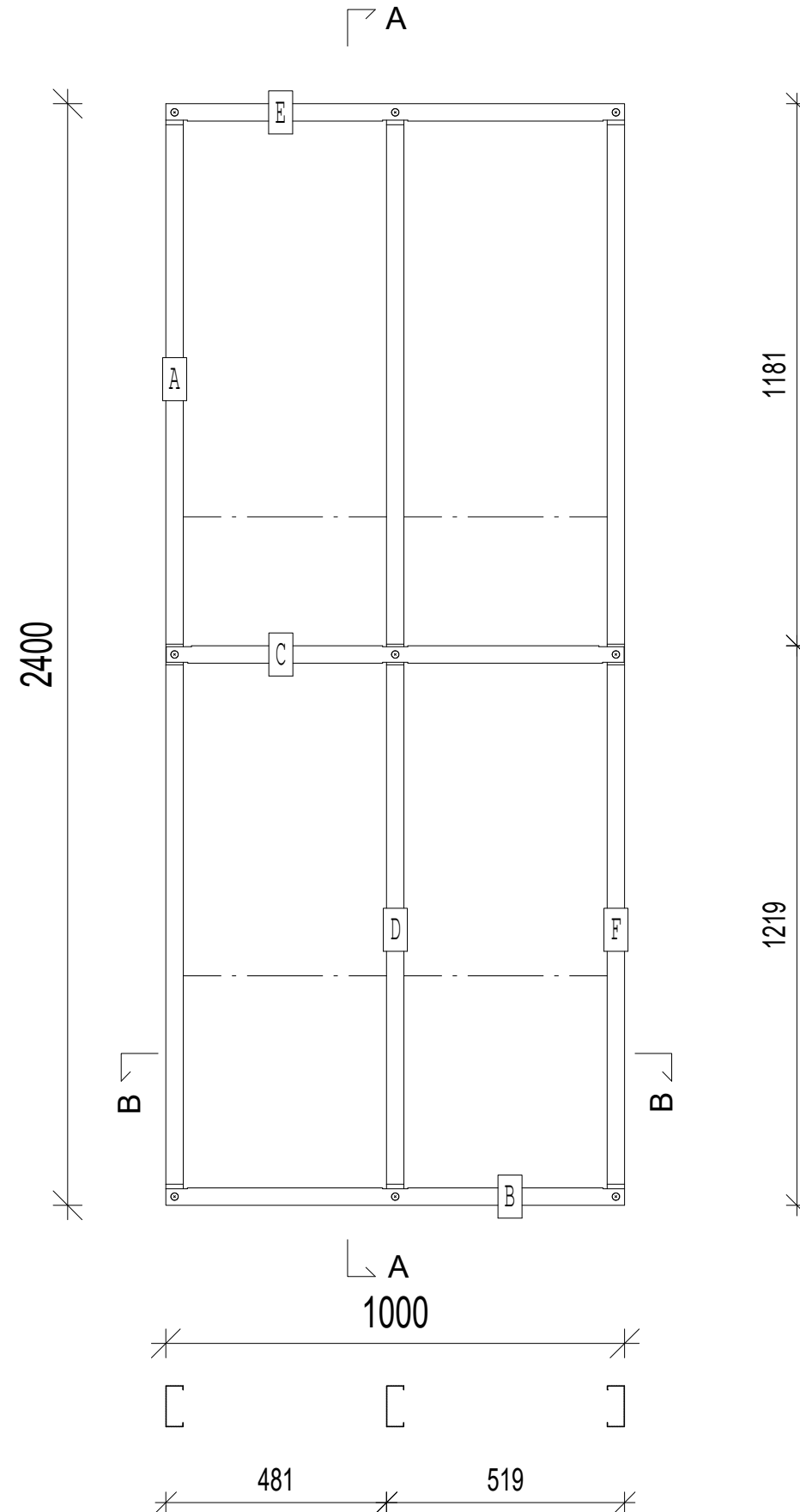
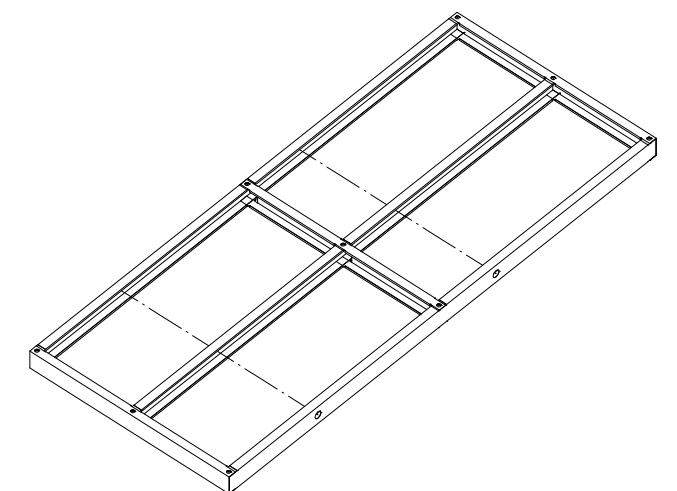
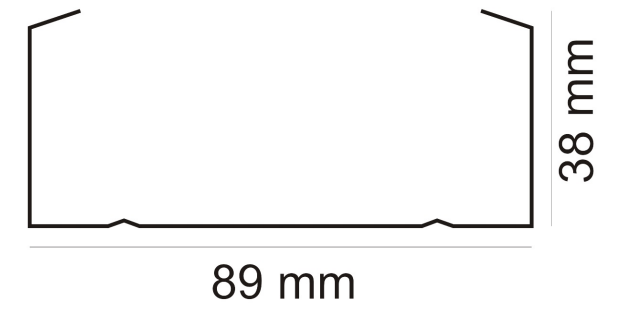
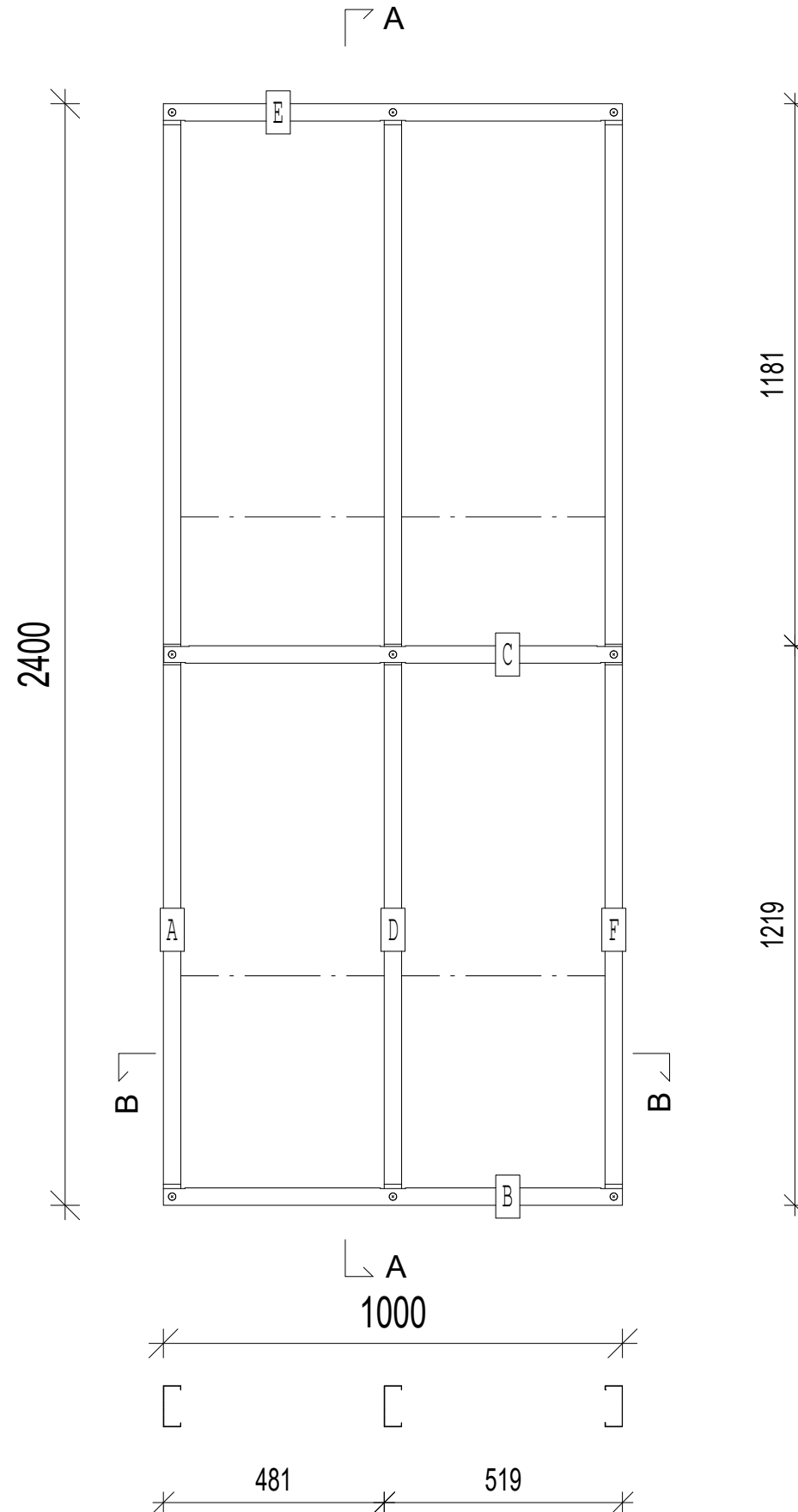

SCHEDULE				
PCE	QTY	MTRL	DESCRIPTION	LENGTH
A	1	C89x38x0.8	STUD	2398
B	1	C89x38x0.8	BOTTOM TRACK	1000
C	1	C89x38x0.8	NOGGIN	998
D	1	C89x38x0.8	STUD	2398
E	1	C89x38x0.8	TOP TRACK	1000
F	1	C89x38x0.8	STUD	2398
Total Length: 10192.00mm				

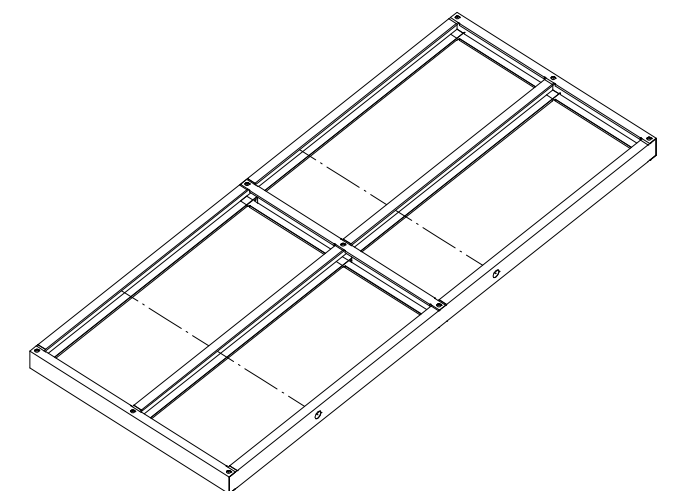
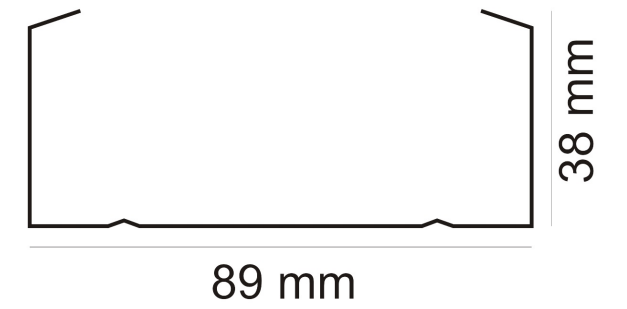
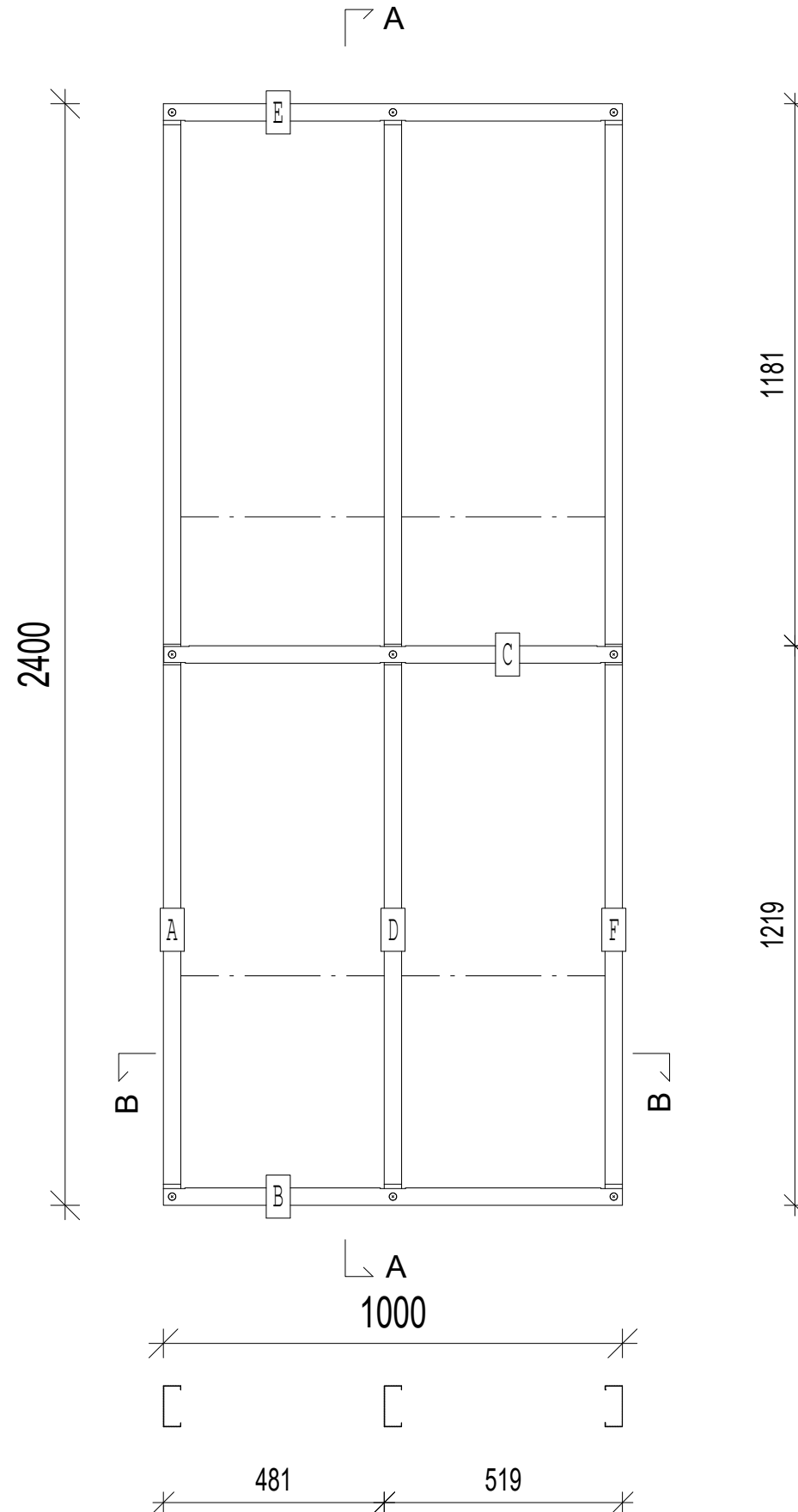

SCHEDULE				
PCE	QTY	MTRL	DESCRIPTION	LENGTH
A	1	C89x38x1.0	STUD	2398
B	1	C89x38x1.0	BOTTOM TRACK	1000
C	1	C89x38x1.0	NOGGIN	998
D	1	C89x38x1.0	STUD	2398
E	1	C89x38x1.0	TOP TRACK	1000
F	1	C89x38x1.0	STUD	2398
Total Length: 10192.00mm				

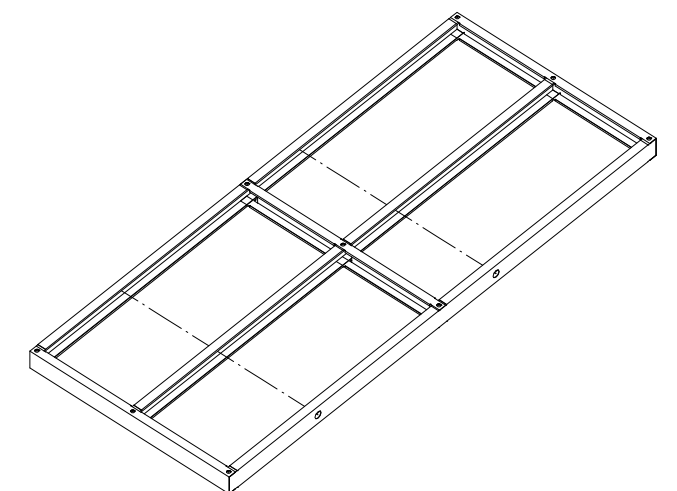
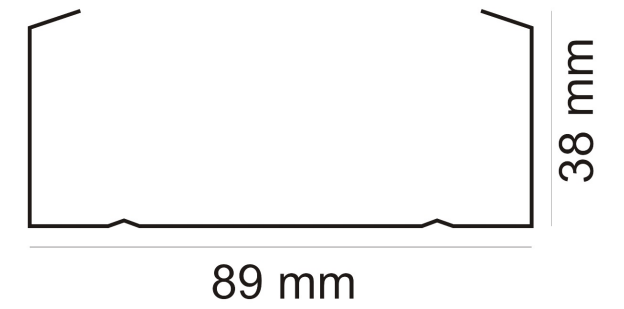
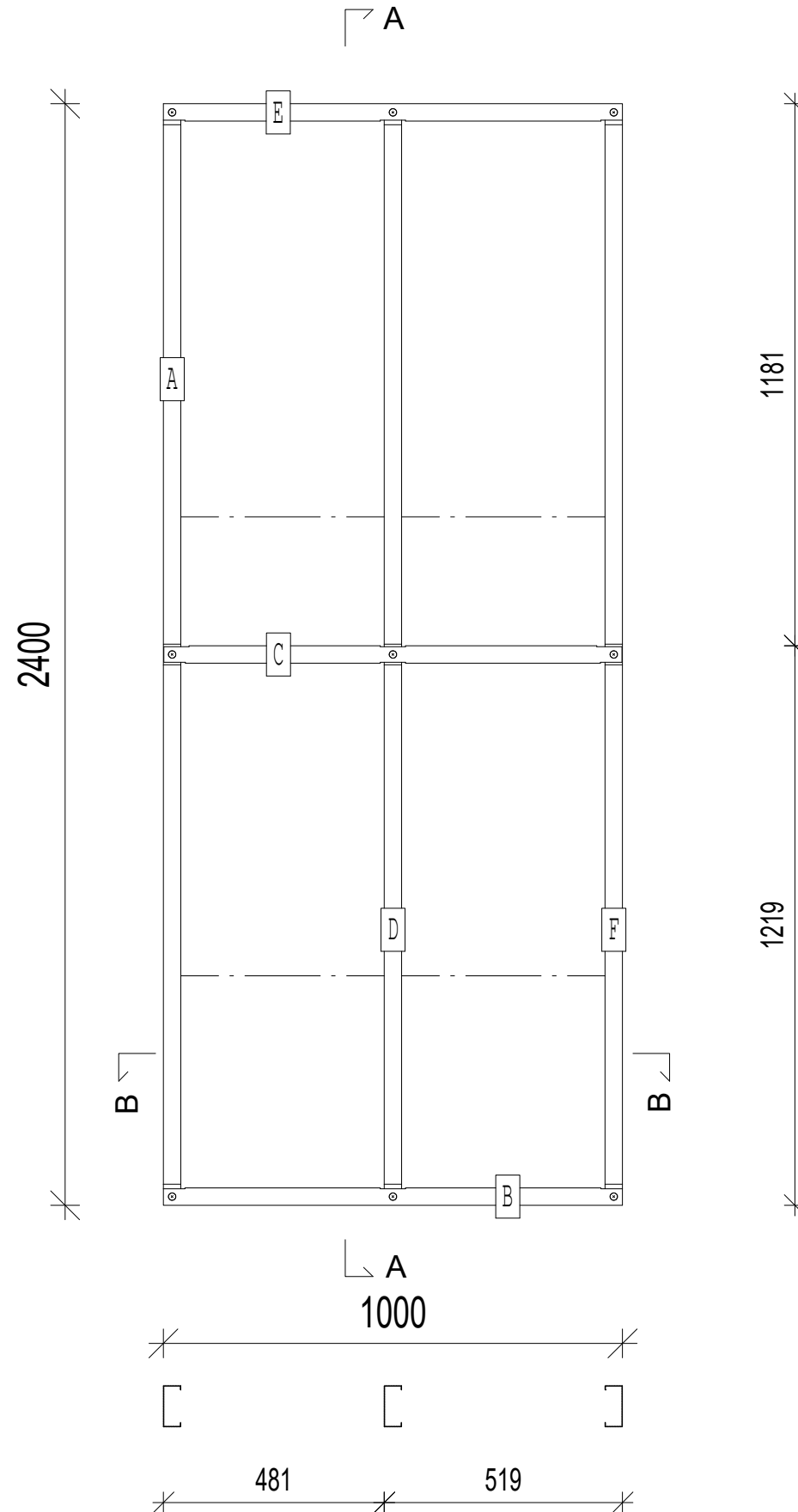

SCHEDULE				
PCE	QTY	MTRL	DESCRIPTION	LENGTH
A	1	C89x38x0.8	STUD	2398
B	2	C89x38x0.8	STUD	2398
C	1	C89x38x0.8	BOTTOM TRACK	2000
D	1	C89x38x0.8	NOGGIN	1998
E	3	C89x38x0.8	STUD	2398
F	1	C89x38x0.8	TOP TRACK	2000
G	1	C89x38x0.8	STUD	2398
Total Length: 22784.00mm				

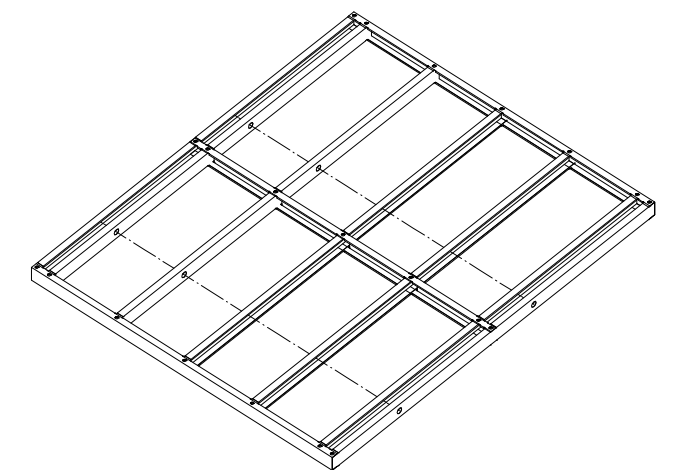
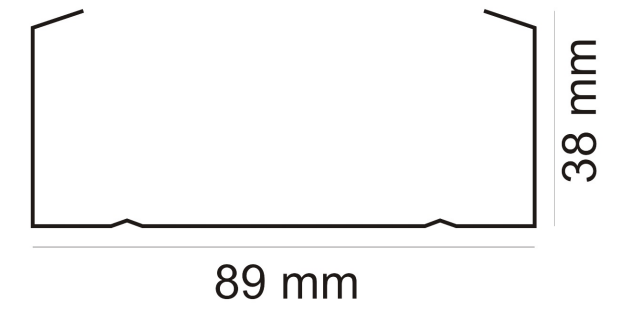
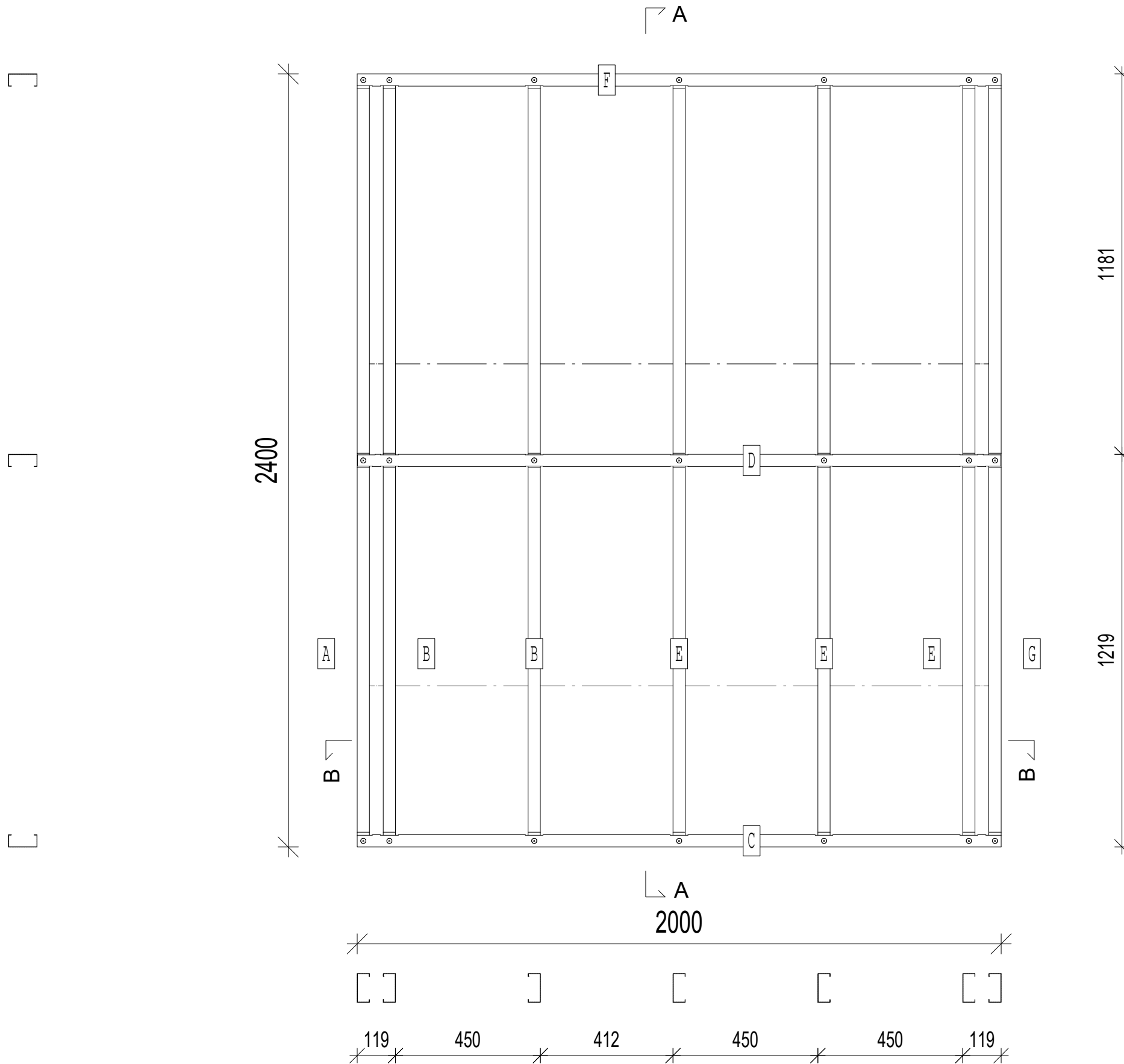

SCHEDULE				
PCE	QTY	MTRL	DESCRIPTION	LENGTH
A	1	C89x38x1.0	STUD	2398
B	1	C89x38x1.0	STUD	2398
C	1	C89x38x1.0	BOTTOM TRACK	2000
D	1	C89x38x1.0	NOGGIN	1998
E	2	C89x38x1.0	STUD	2398
F	1	C89x38x1.0	TOP TRACK	2000
G	1	C89x38x1.0	STUD	2398
Total Length: 17988.00mm				

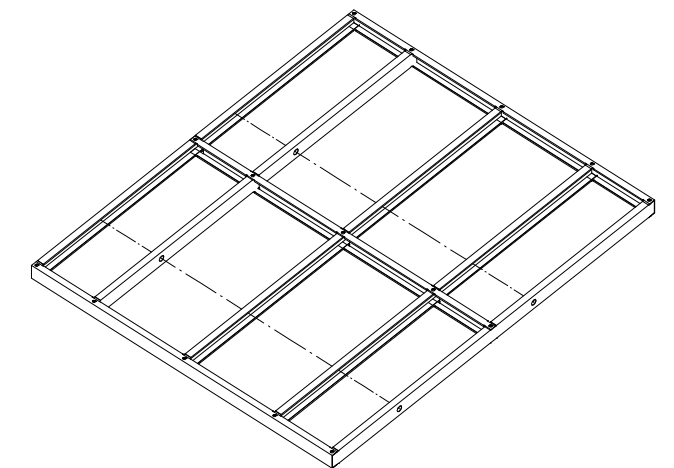
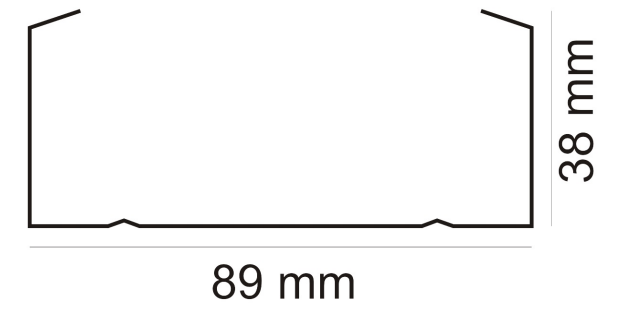
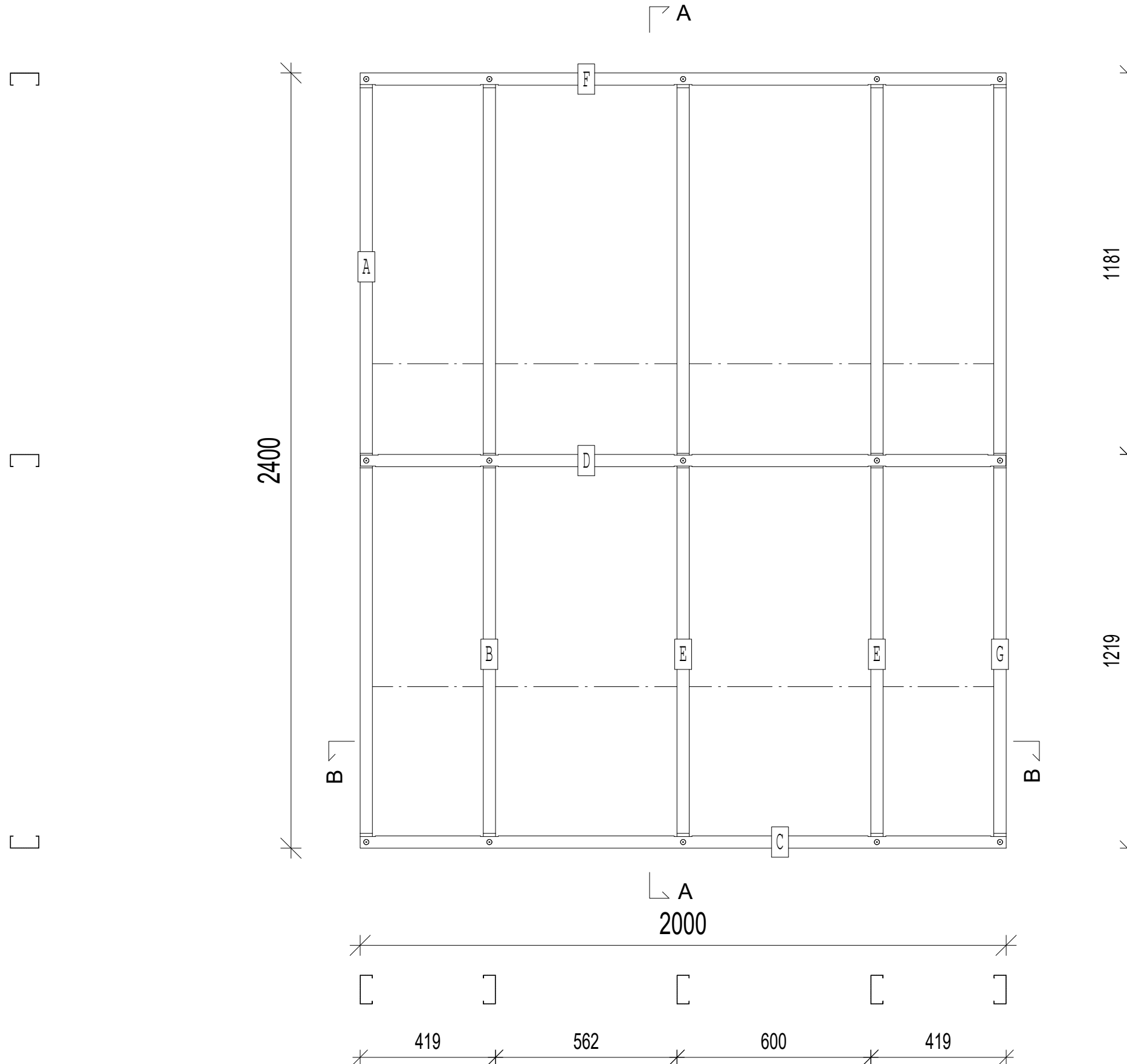

SCHEDULE				
PCE	QTY	MTRL	DESCRIPTION	LENGTH
A	1	C89x38x1.0	STUD	2398
B	2	C89x38x1.0	STUD	2398
C	1	C89x38x1.0	BOTTOM TRACK	2000
D	1	C89x38x1.0	NOGGIN	1998
E	3	C89x38x1.0	STUD	2398
F	1	C89x38x1.0	TOP TRACK	2000
G	1	C89x38x1.0	STUD	2398
Total Length: 22784.00mm				

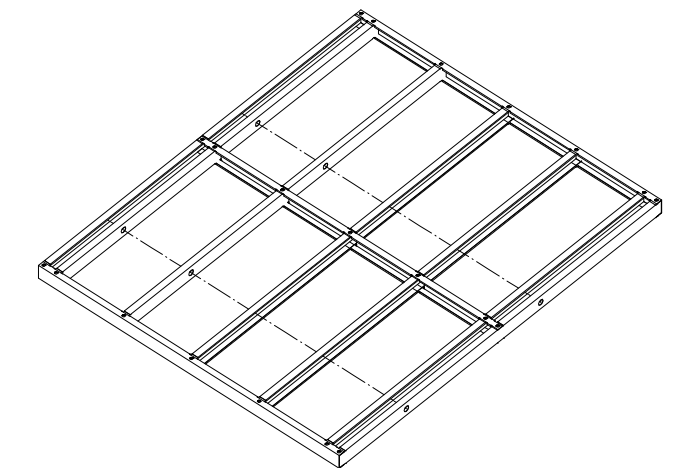
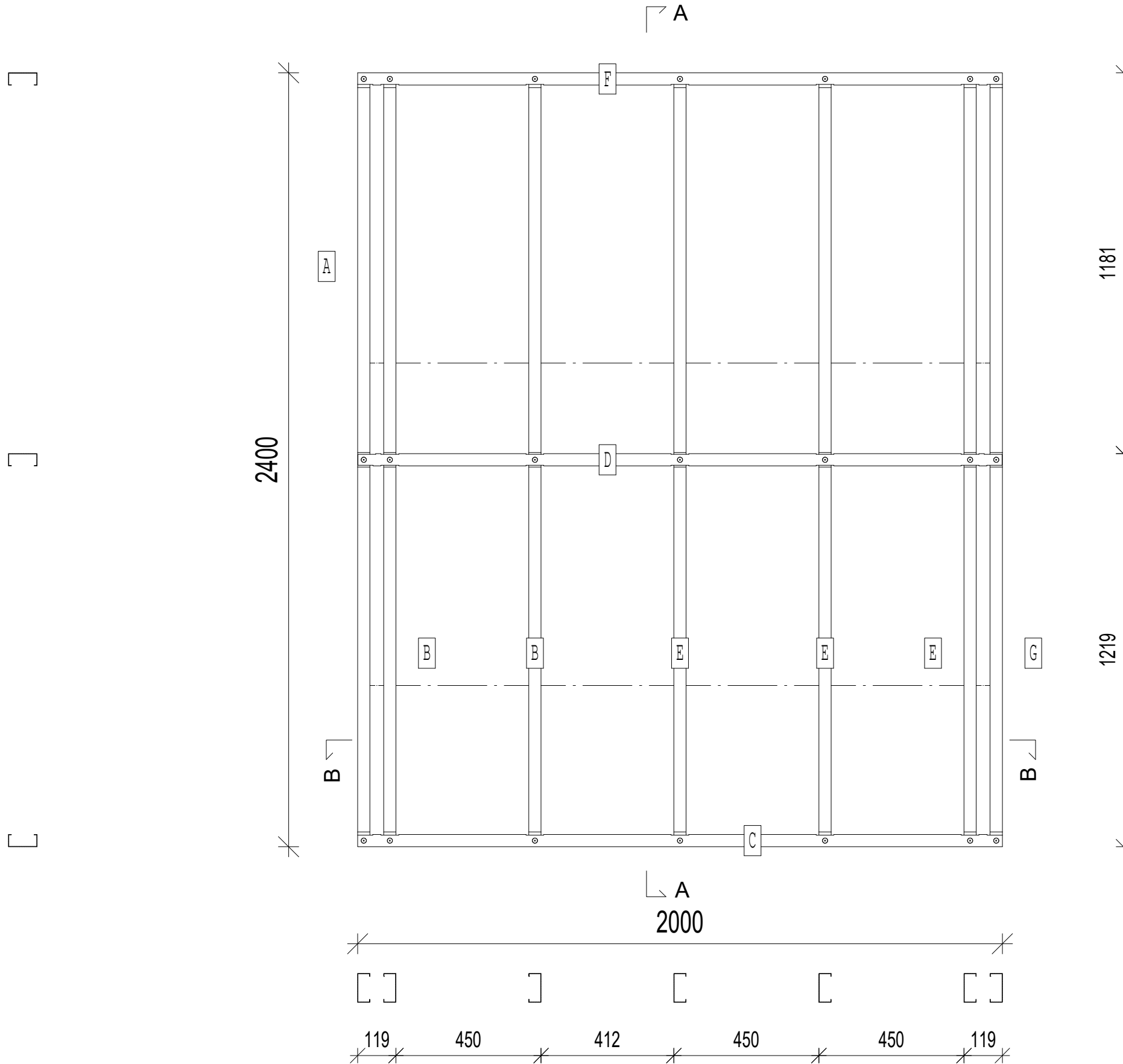

SCHEDULE				
PCE	QTY	MTRL	DESCRIPTION	LENGTH
A	1	C89x38x0.8	STUD	2398
B	1	C89x38x0.8	STUD	2398
C	1	C89x38x0.8	BOTTOM TRACK	2000
D	1	C89x38x0.8	NOGGIN	1998
E	2	C89x38x0.8	STUD	2398
F	1	C89x38x0.8	TOP TRACK	2000
G	1	C89x38x0.8	STUD	2398
Total Length: 17988.00mm				

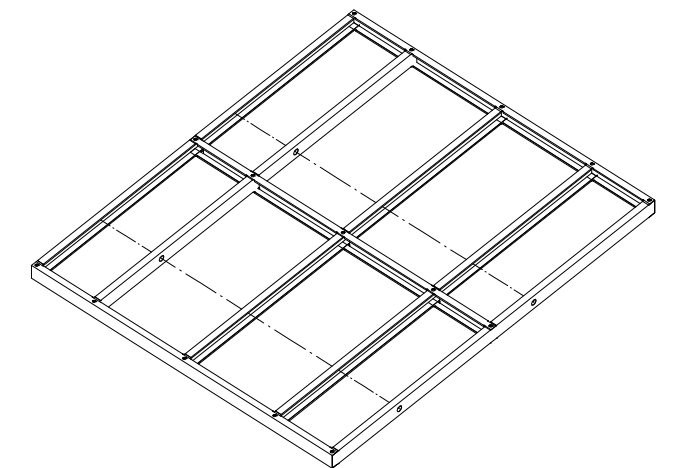
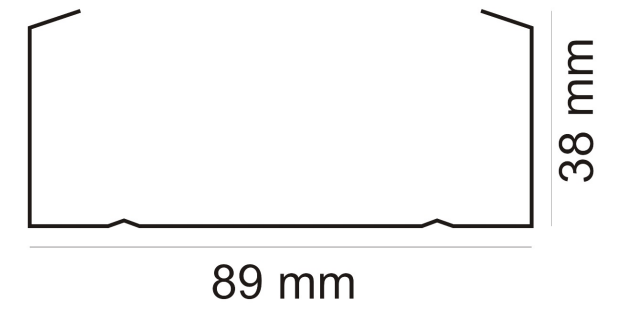
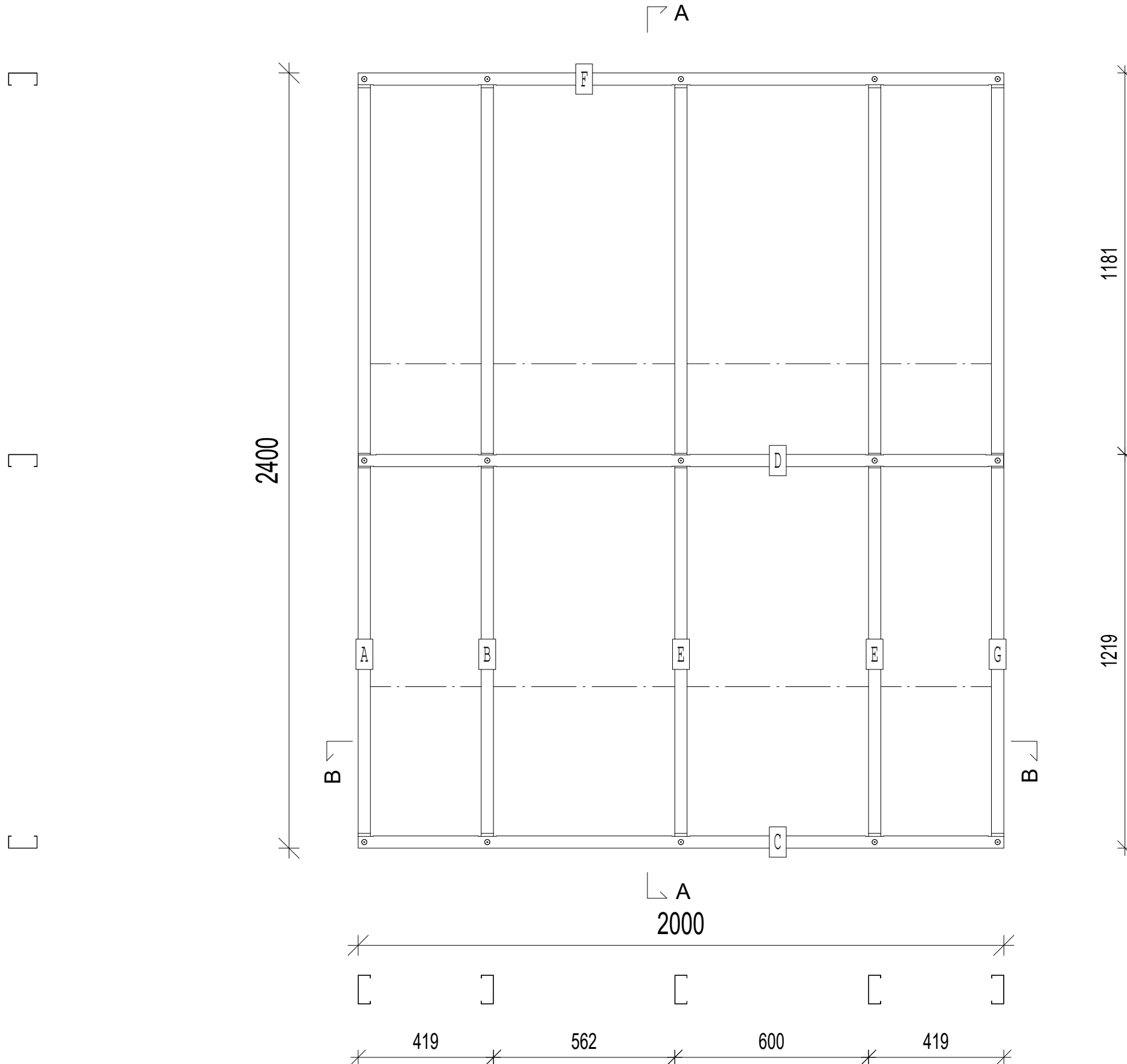



SCHEDULE				
PCE	QTY	MTRL	DESCRIPTION	LENGTH
A	1	C89x38x1.0	STUD	2398
B	3	C89x38x1.0	STUD	2398
C	1	C89x38x1.0	BOTTOM TRACK	3000
D	1	C89x38x1.0	NOGGIN	2998
E	4	C89x38x1.0	STUD	2398
F	1	C89x38x1.0	TOP TRACK	3000
G	1	C89x38x1.0	STUD	2398
Total Length: 30580.00mm				

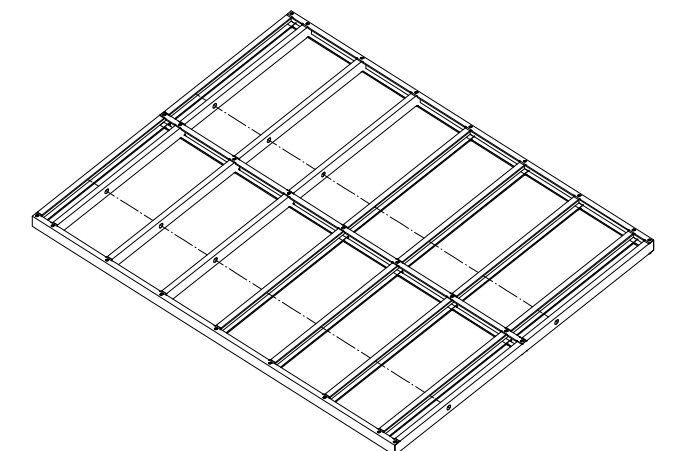
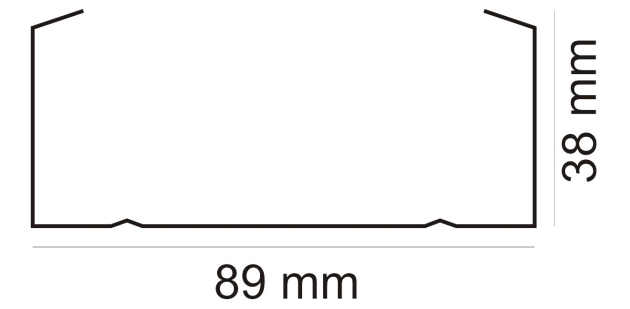
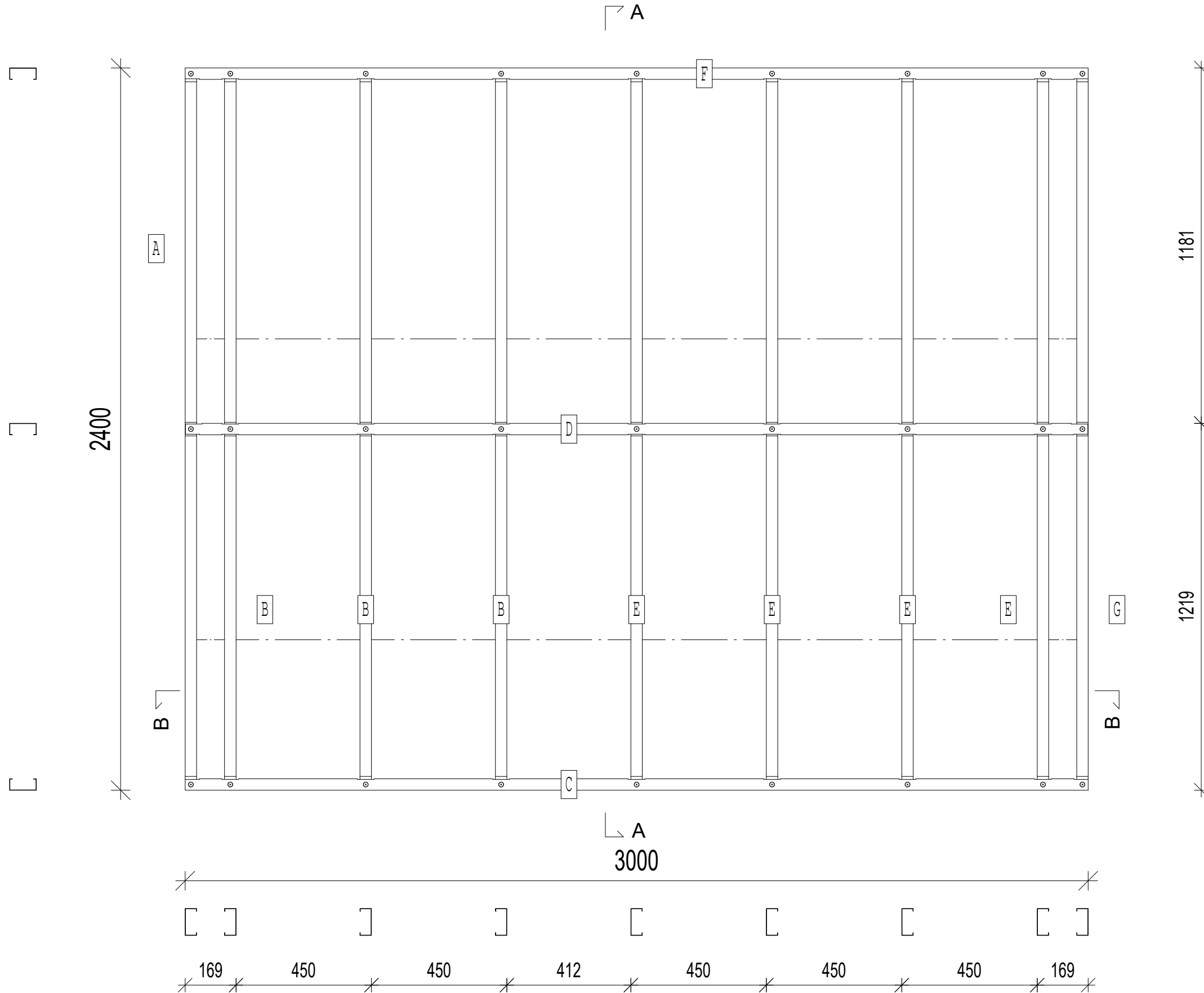

SCHEDULE				
PCE	QTY	MTRL	DESCRIPTION	LENGTH
A	1	C89x38x0.8	STUD	2398
B	2	C89x38x0.8	STUD	2398
C	1	C89x38x0.8	BOTTOM TRACK	3000
D	1	C89x38x0.8	NOGGIN	2998
E	3	C89x38x0.8	STUD	2398
F	1	C89x38x0.8	TOP TRACK	3000
G	1	C89x38x0.8	STUD	2398
Total Length: 25784.00mm				

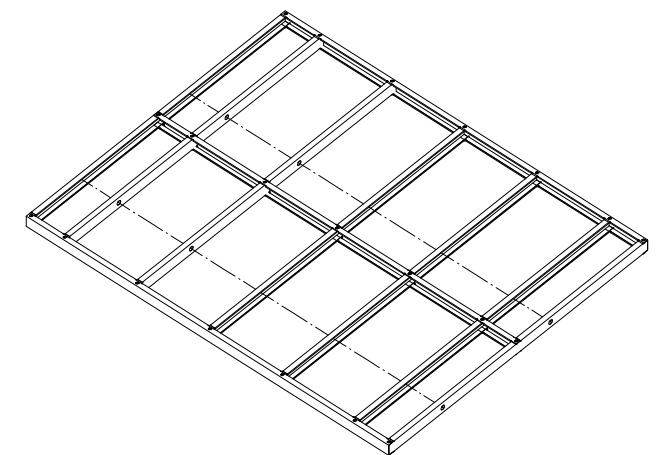
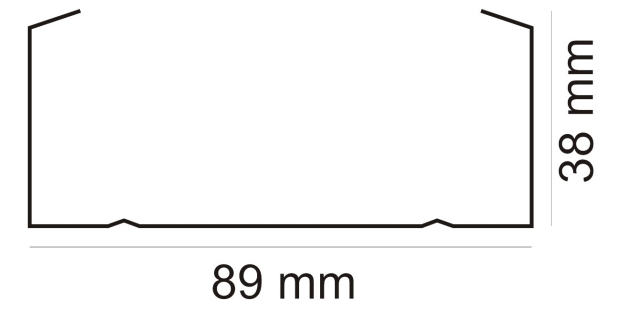
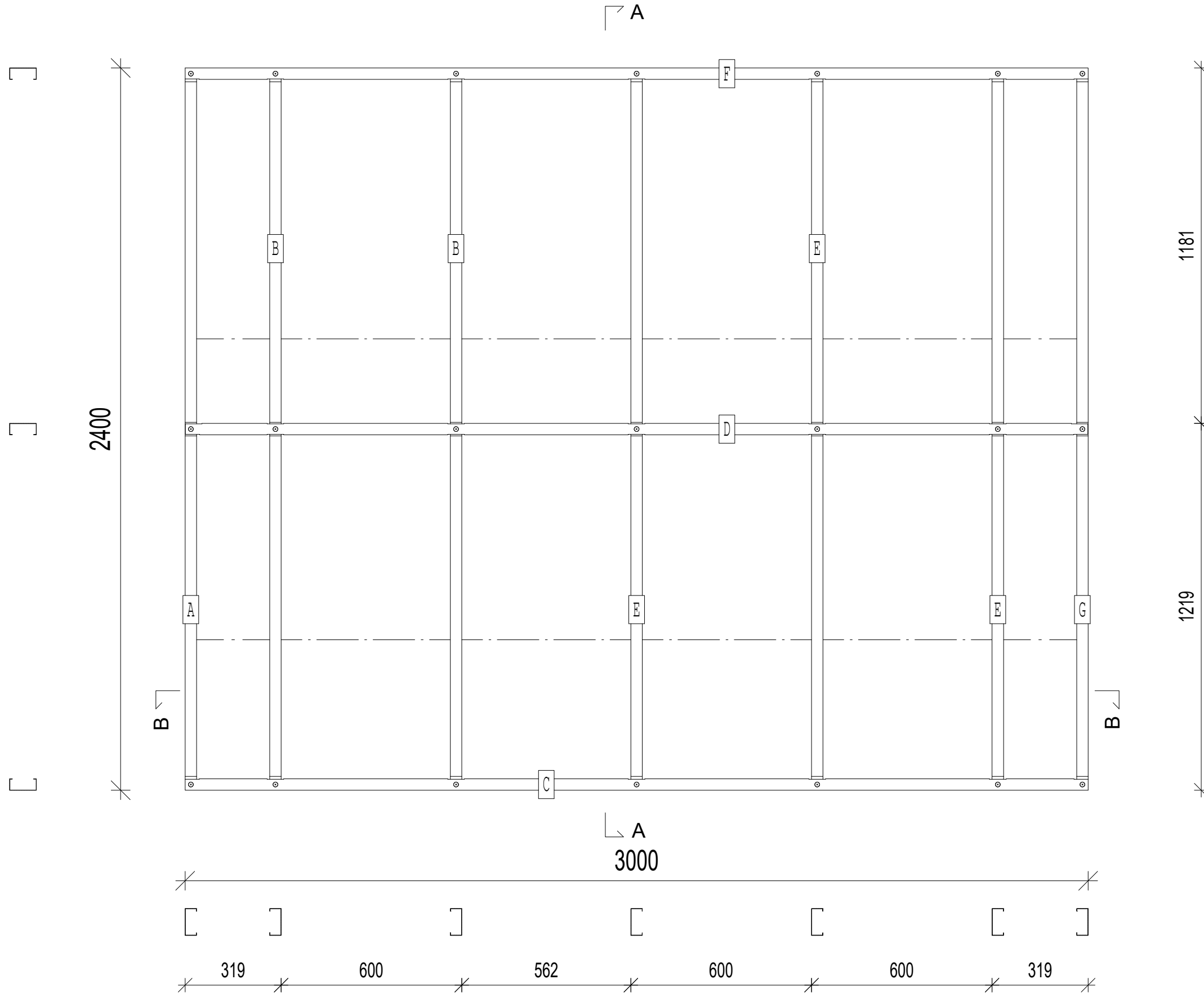

SCHEDULE				
PCE	QTY	MTRL	DESCRIPTION	LENGTH
A	1	C89x38x0.8	STUD	2398
B	3	C89x38x0.8	STUD	2398
C	1	C89x38x0.8	BOTTOM TRACK	3000
D	1	C89x38x0.8	NOGGIN	2998
E	4	C89x38x0.8	STUD	2398
F	1	C89x38x0.8	TOP TRACK	3000
G	1	C89x38x0.8	STUD	2398
Total Length: 30580.00mm				

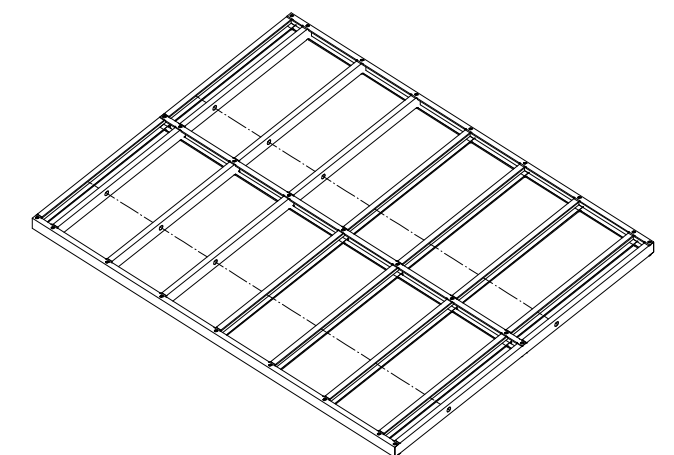
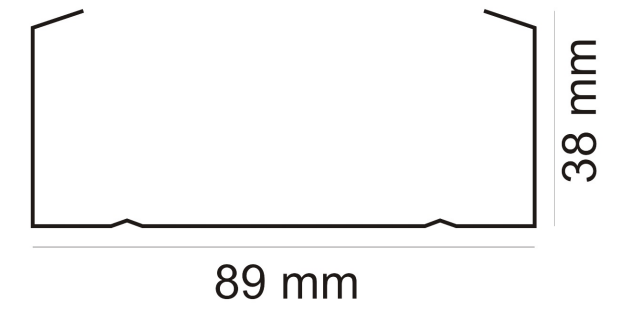
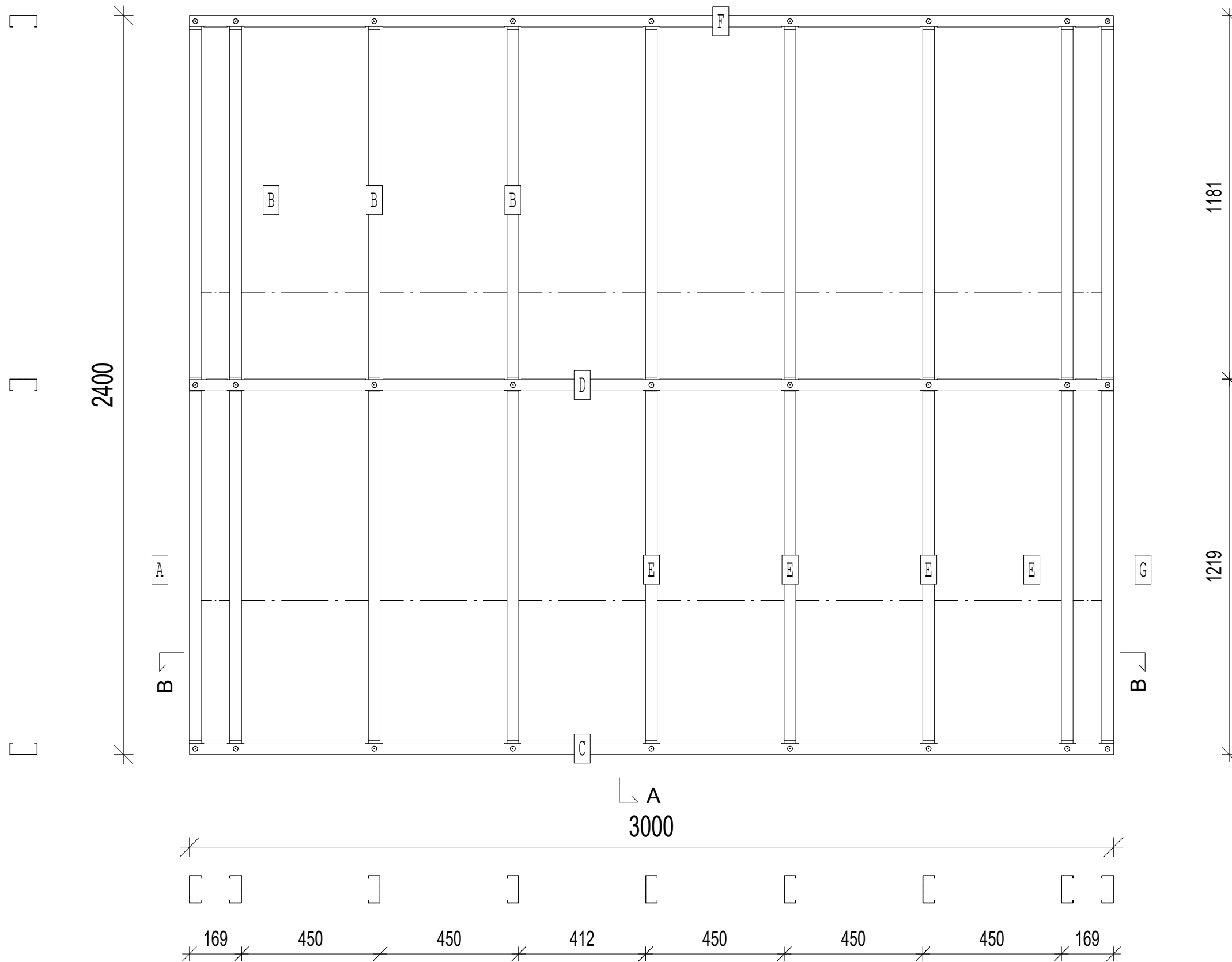

SCHEDULE				
PCE	QTY	MTRL	DESCRIPTION	LENGTH
A	1	C89x38x1.0	STUD	2398
B	2	C89x38x1.0	STUD	2398
C	1	C89x38x1.0	BOTTOM TRACK	3000
D	1	C89x38x1.0	NOGGIN	2998
E	3	C89x38x1.0	STUD	2398
F	1	C89x38x1.0	TOP TRACK	3000
G	1	C89x38x1.0	STUD	2398
Total Length: 25784.00mm				

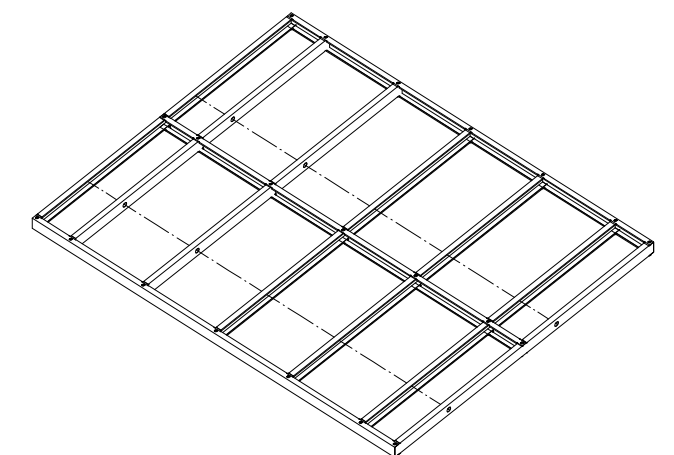
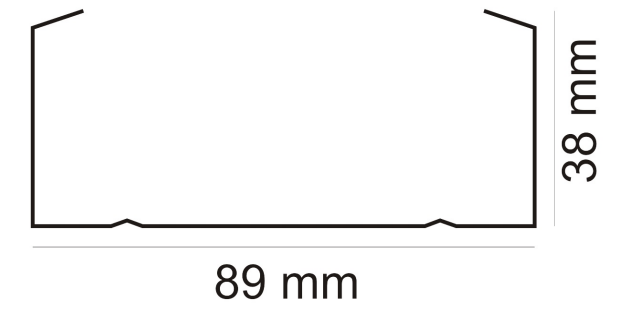
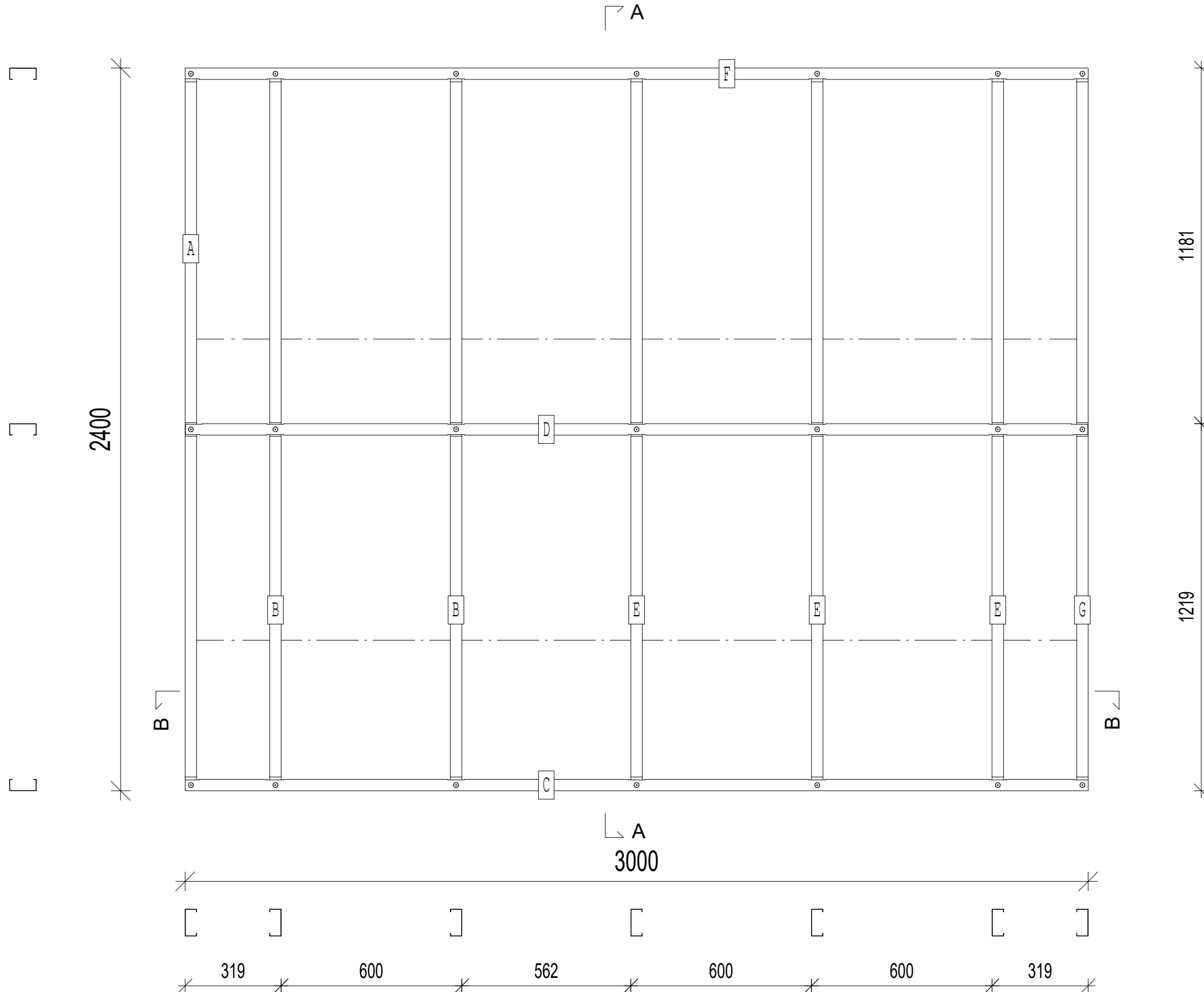

SCHEDULE				
PCE	QTY	MTRL	DESCRIPTION	LENGTH
A	1	C89x38x0.8	STUD	2398
B	4	C89x38x0.8	STUD	2398
C	1	C89x38x0.8	BOTTOM TRACK	4000
D	1	C89x38x0.8	NOGGIN	3998
E	5	C89x38x0.8	STUD	2398
F	1	C89x38x0.8	TOP TRACK	4000
G	1	C89x38x0.8	STUD	2398
Total Length: 38376.00mm				

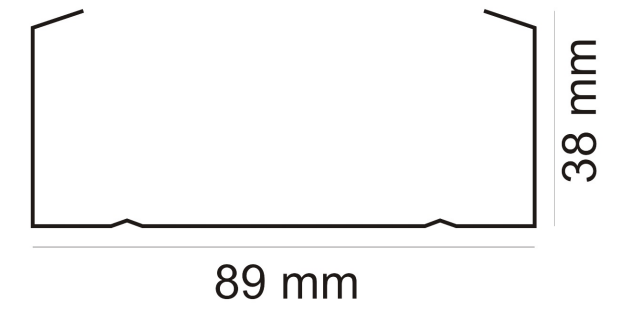
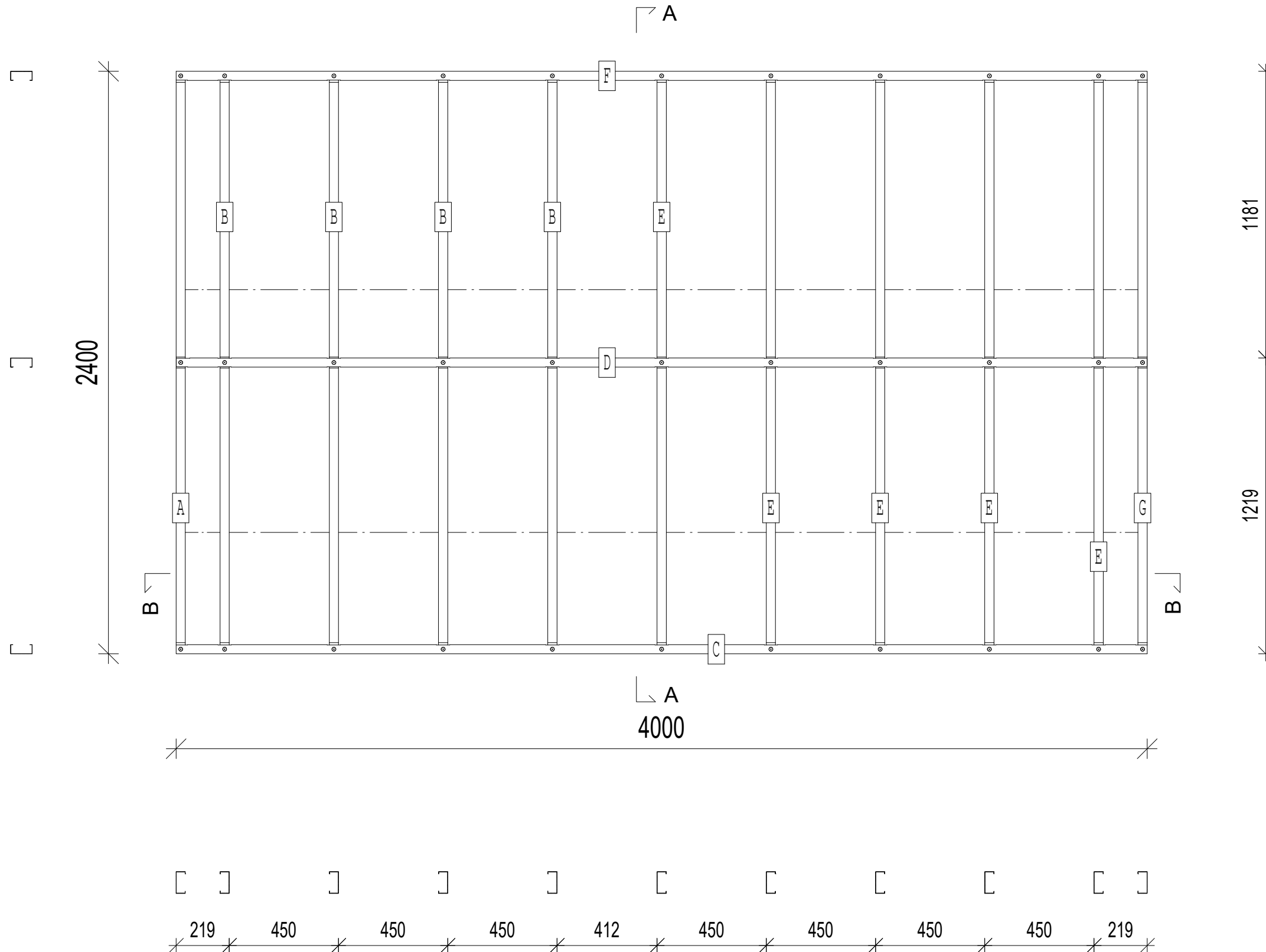

SCHEDULE				
PCE	QTY	MTRL	DESCRIPTION	LENGTH
A	1	C89x38x0.8	STUD	2398
B	3	C89x38x0.8	STUD	2398
C	1	C89x38x0.8	BOTTOM TRACK	4000
D	1	C89x38x0.8	NOGGIN	3998
E	4	C89x38x0.8	STUD	2398
F	1	C89x38x0.8	TOP TRACK	4000
G	1	C89x38x0.8	STUD	2398
Total Length: 33580.00mm				

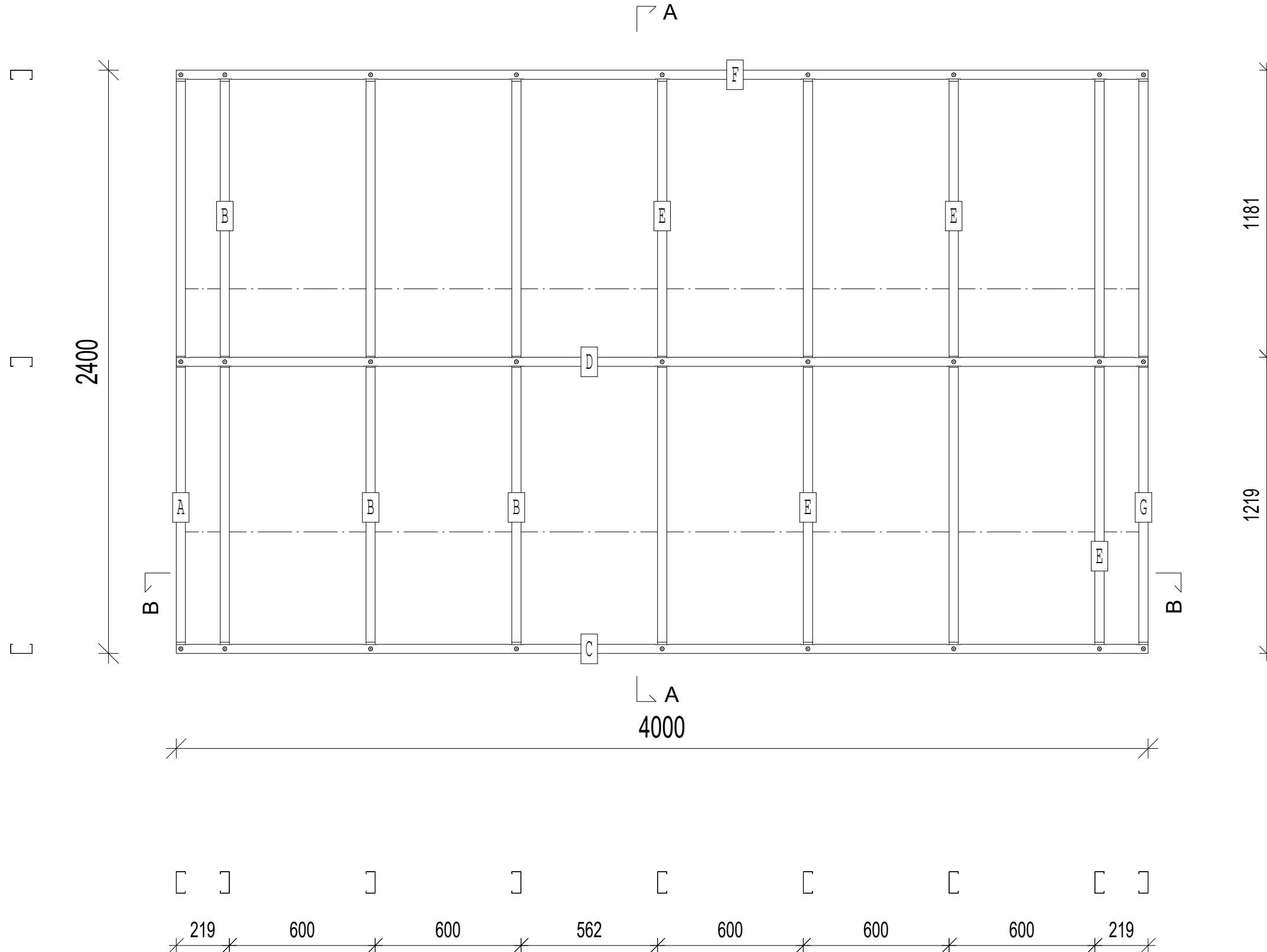

SCHEDULE				
PCE	QTY	MTRL	DESCRIPTION	LENGTH
A	1	C89x38x1.0	STUD	2398
B	3	C89x38x1.0	STUD	2398
C	1	C89x38x1.0	BOTTOM TRACK	4000
D	1	C89x38x1.0	NOGGIN	3998
E	4	C89x38x1.0	STUD	2398
F	1	C89x38x1.0	TOP TRACK	4000
G	1	C89x38x1.0	STUD	2398
Total Length: 33580.00mm				

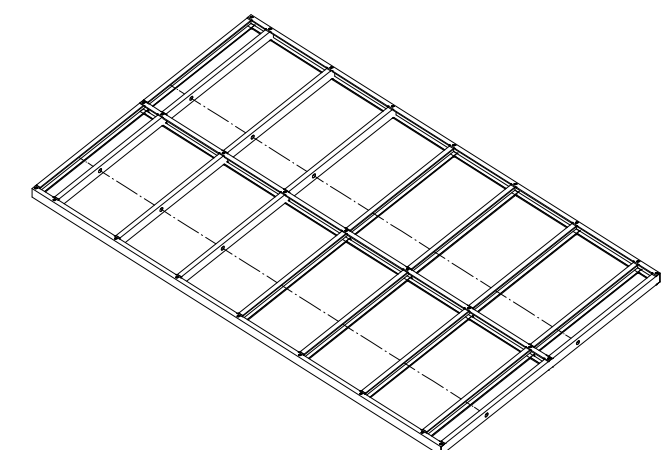
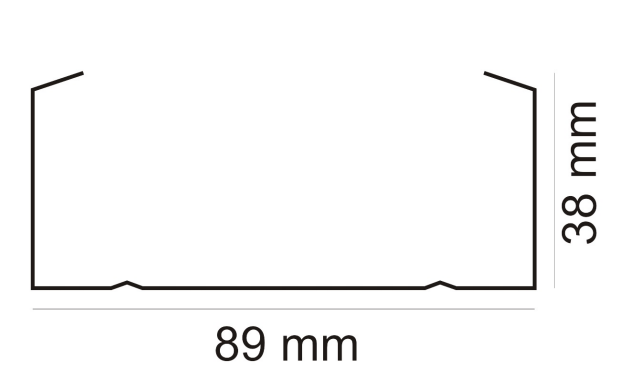
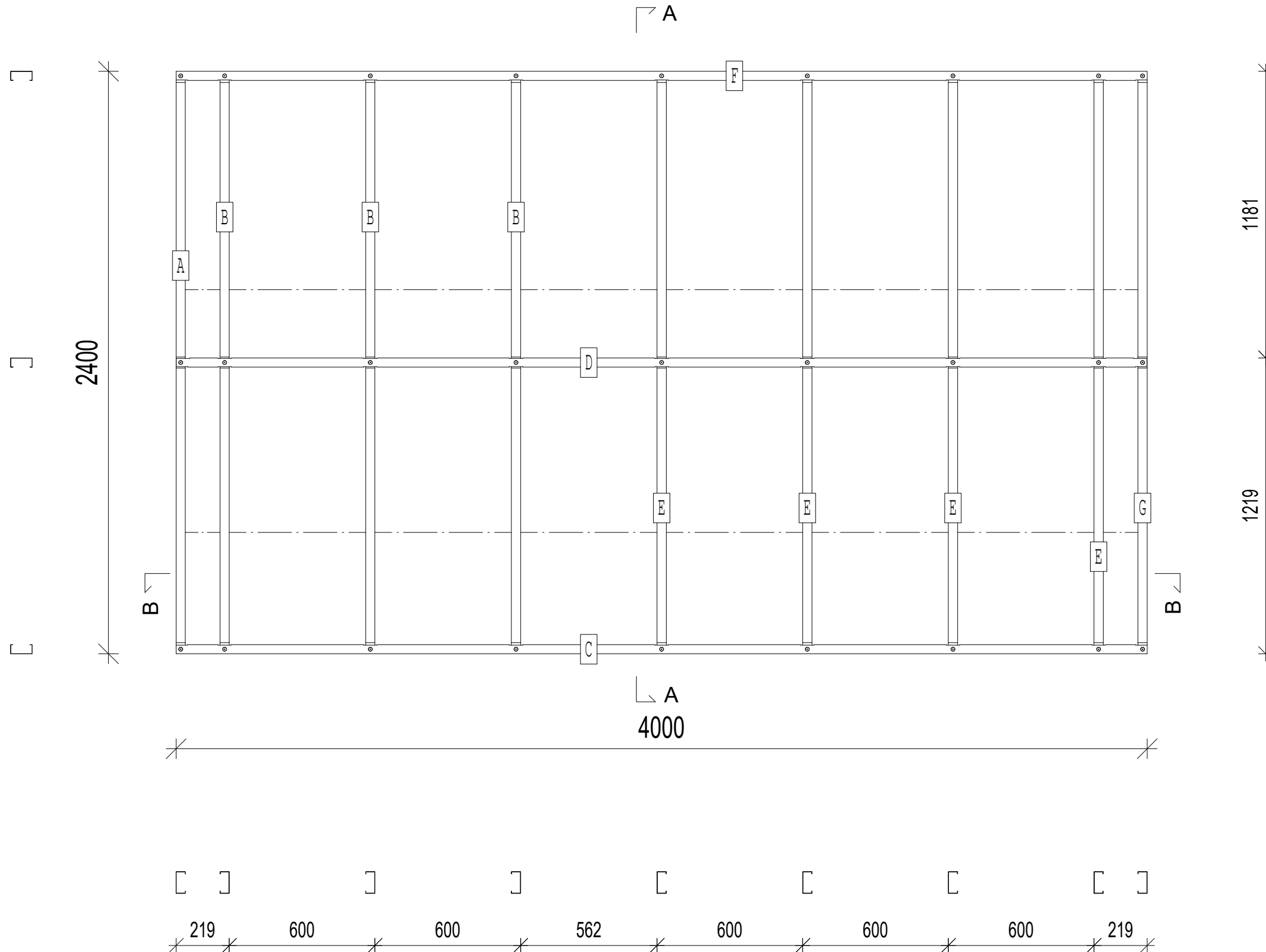

SCHEDULE				
PCE	QTY	MTRL	DESCRIPTION	LENGTH
A	1	C89x38x1.0	STUD	2398
B	4	C89x38x1.0	STUD	2398
C	1	C89x38x1.0	BOTTOM TRACK	4000
D	1	C89x38x1.0	NOGGIN	3998
E	5	C89x38x1.0	STUD	2398
F	1	C89x38x1.0	TOP TRACK	4000
G	1	C89x38x1.0	STUD	2398
Total Length: 38376.00mm				

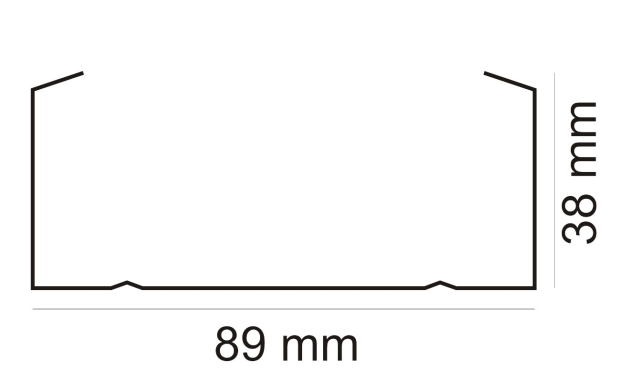
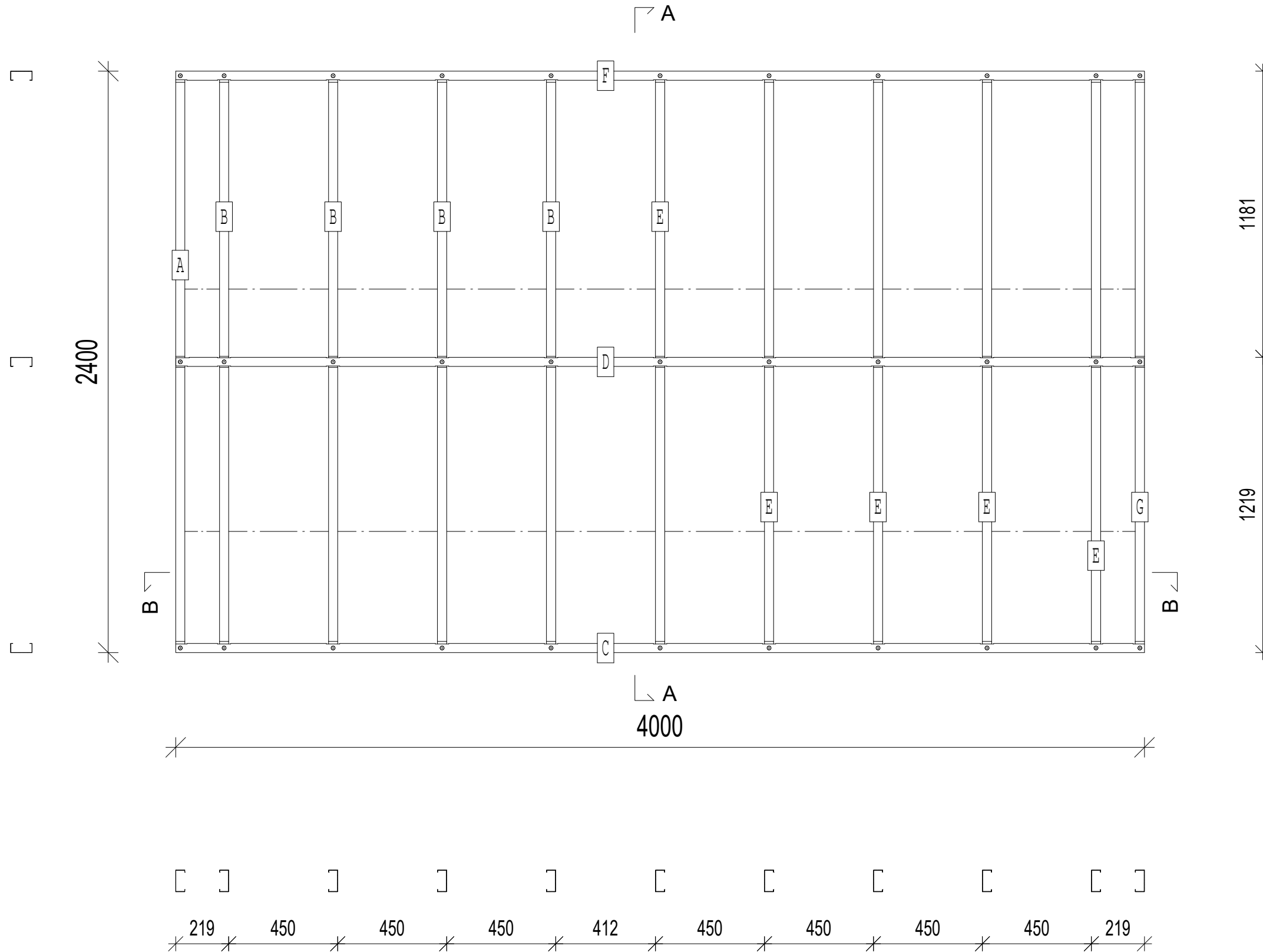



SCHEDULE				
PCE	QTY	MTRL	DESCRIPTION	LENGTH
A	1	C89x38x0.8	STUD	2398
B	4	C89x38x0.8	STUD	2398
C	1	C89x38x0.8	BOTTOM TRACK	5000
D	1	C89x38x0.8	NOGGIN	4998
E	5	C89x38x0.8	STUD	2398
F	1	C89x38x0.8	TOP TRACK	5000
G	1	C89x38x0.8	STUD	2398
Total Length: 41376.00mm				

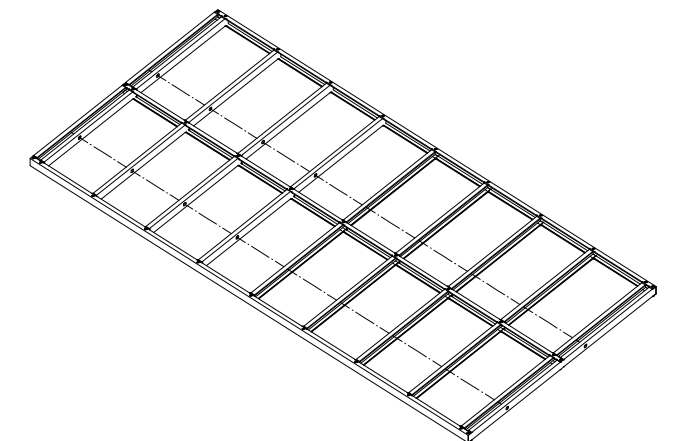
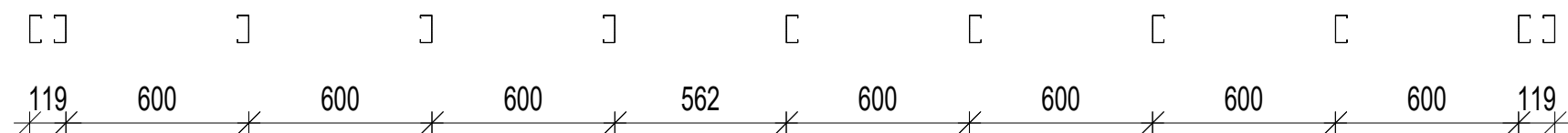
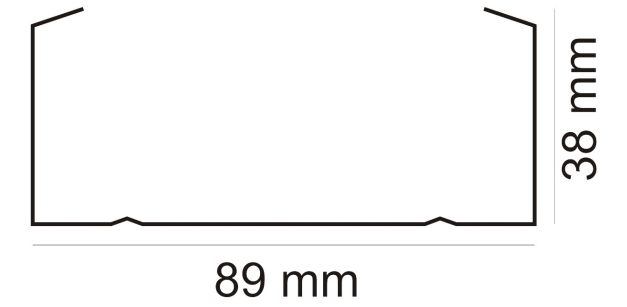
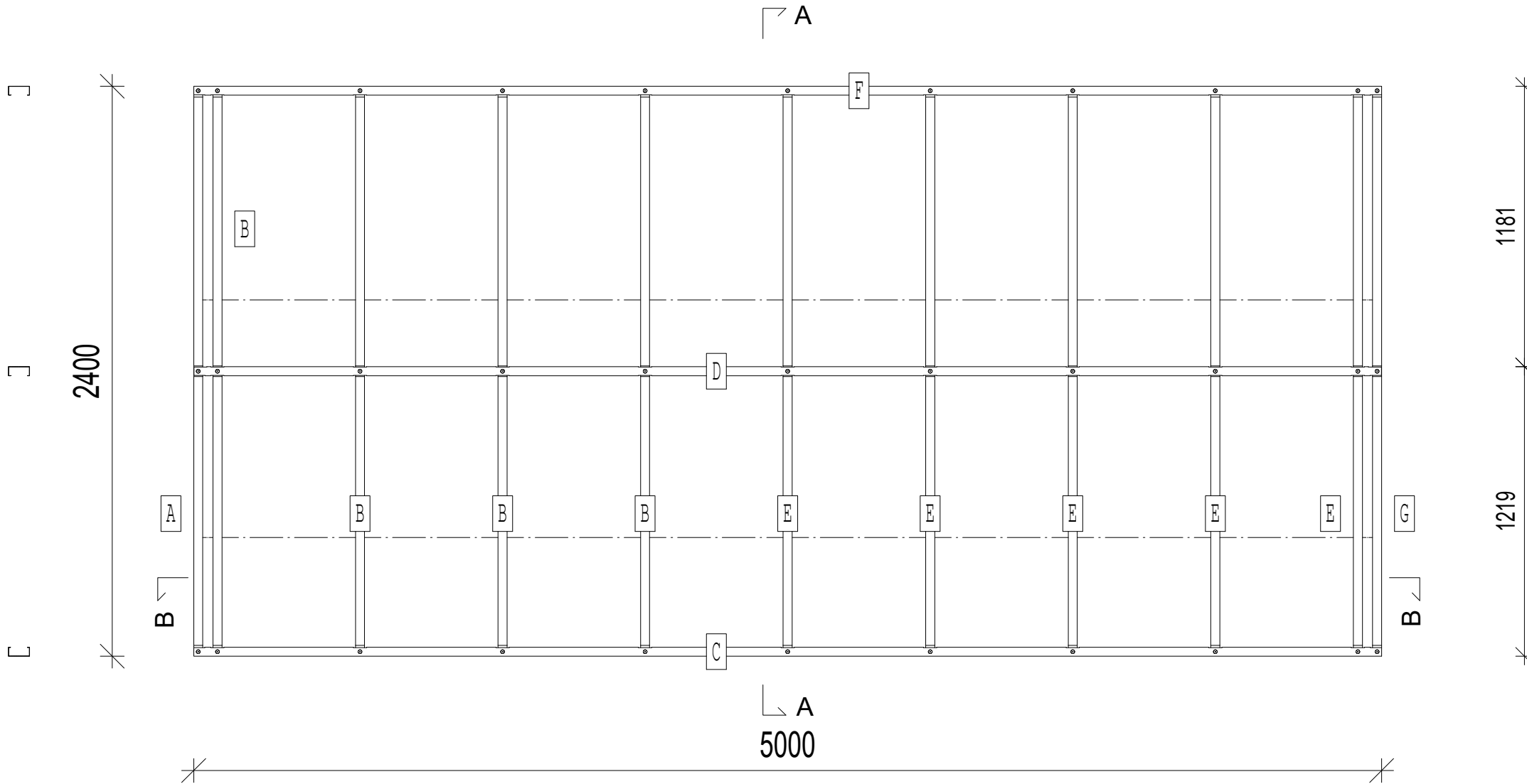

SCHEDULE				
PCE	QTY	MTRL	DESCRIPTION	LENGTH
A	1	C89x38x1.0	STUD	2398
B	5	C89x38x1.0	STUD	2398
C	1	C89x38x1.0	BOTTOM TRACK	5000
D	1	C89x38x1.0	NOGGIN	4998
E	6	C89x38x1.0	STUD	2398
F	1	C89x38x1.0	TOP TRACK	5000
G	1	C89x38x1.0	STUD	2398
Total Length: 46172.00mm				

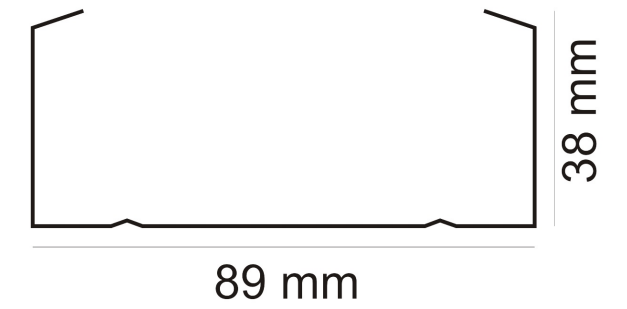
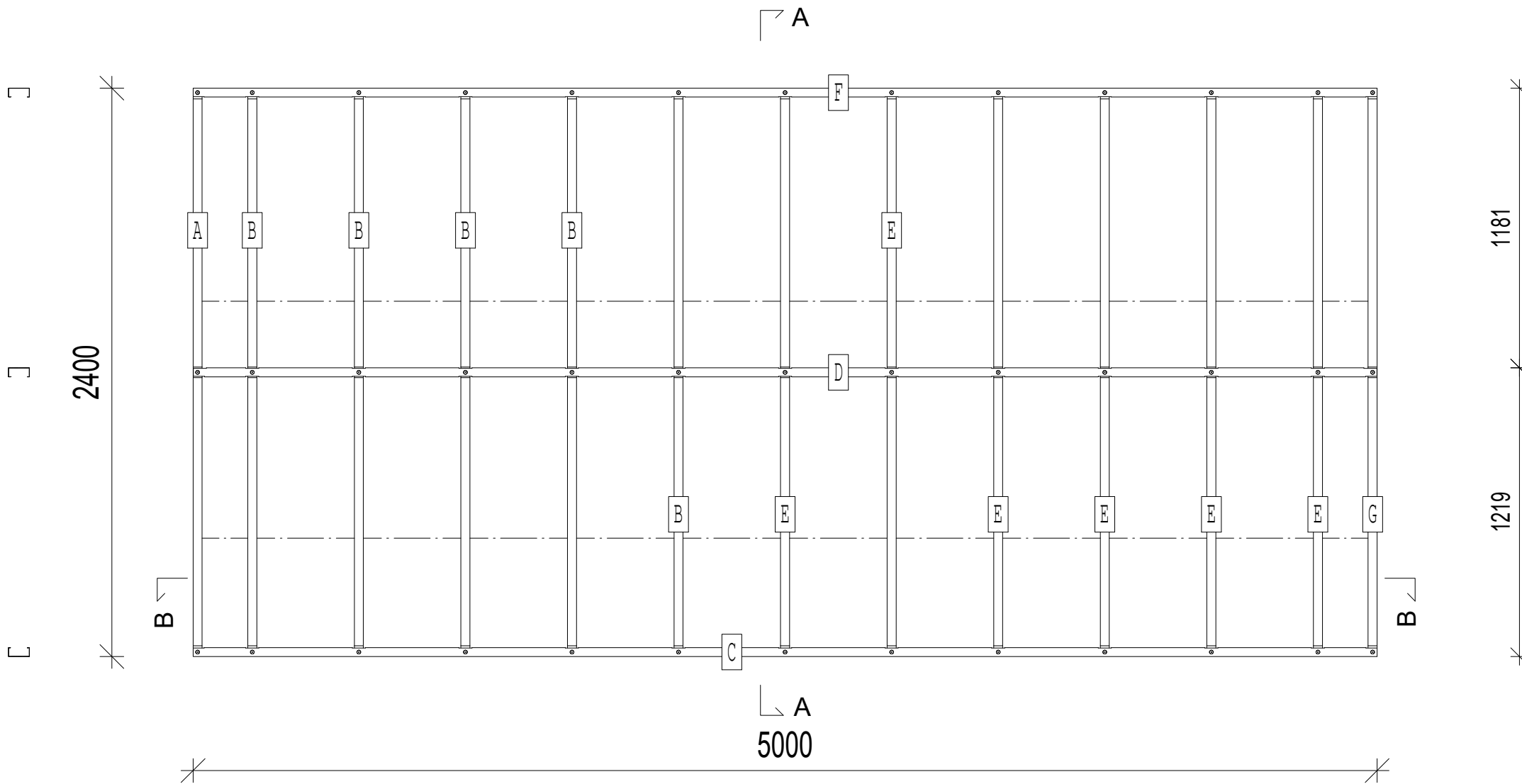

SCHEDULE				
PCE	QTY	MTRL	DESCRIPTION	LENGTH
A	1	C89x38x0.8	STUD	2398
B	5	C89x38x0.8	STUD	2398
C	1	C89x38x0.8	BOTTOM TRACK	5000
D	1	C89x38x0.8	NOGGIN	4998
E	6	C89x38x0.8	STUD	2398
F	1	C89x38x0.8	TOP TRACK	5000
G	1	C89x38x0.8	STUD	2398
Total Length: 46172.00mm				

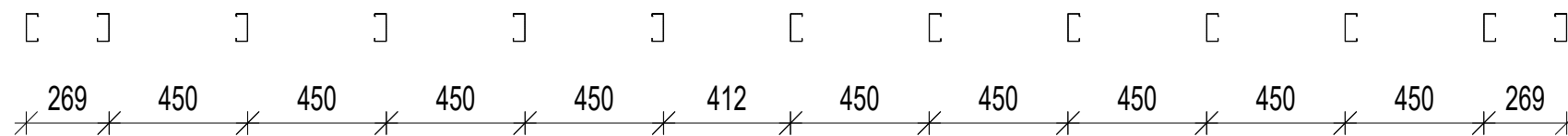
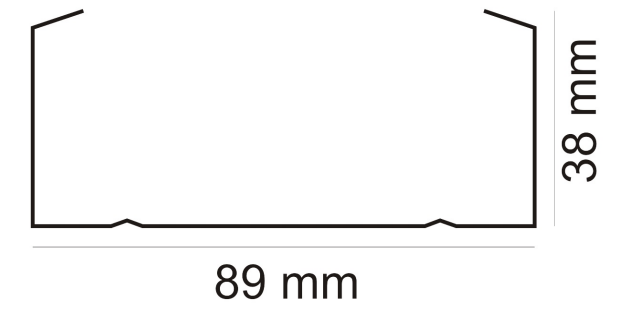
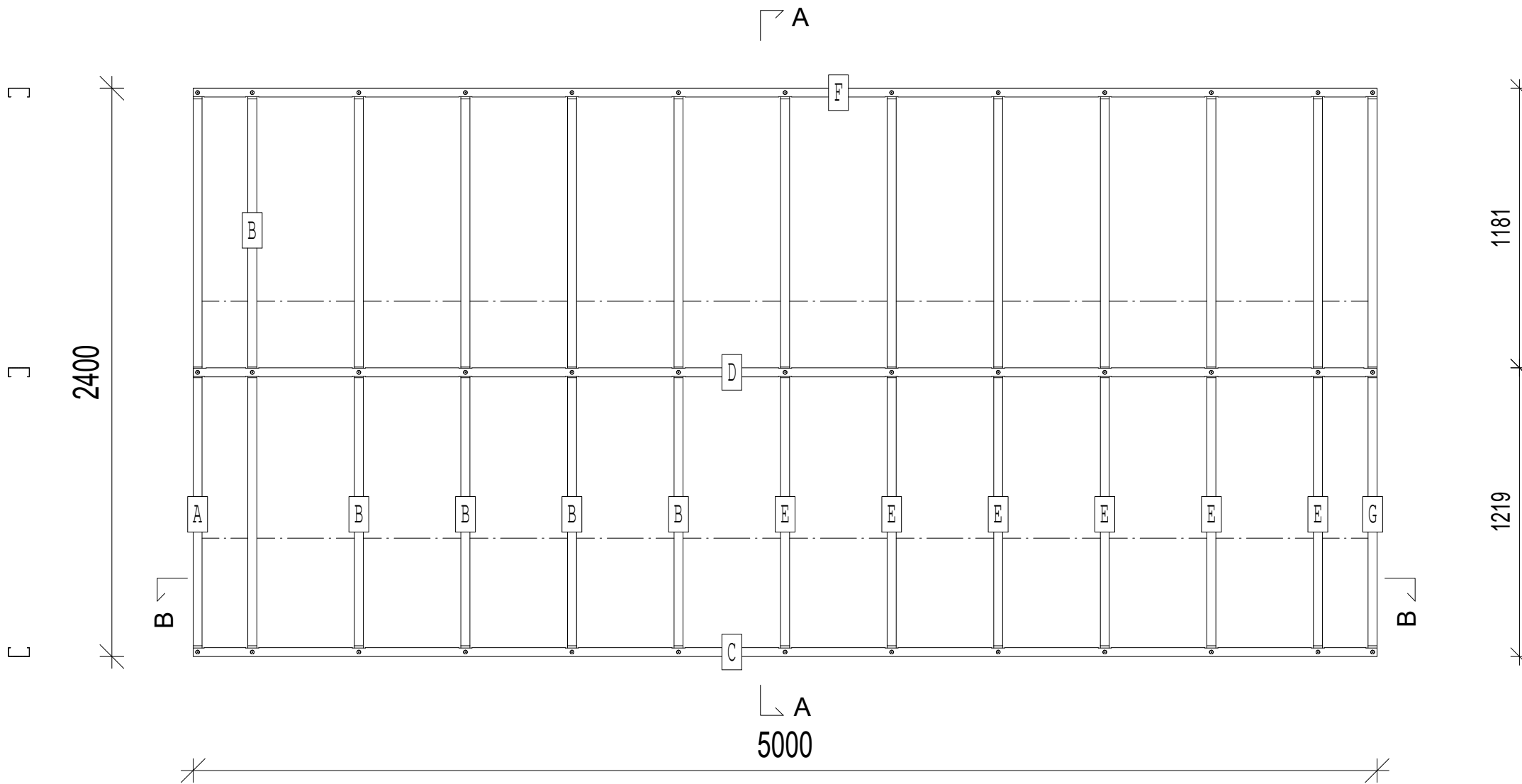

SCHEDULE				
PCE	QTY	MTRL	DESCRIPTION	LENGTH
A	1	C89x38x1.0	STUD	2398
B	4	C89x38x1.0	STUD	2398
C	1	C89x38x1.0	BOTTOM TRACK	5000
D	1	C89x38x1.0	NOGGIN	4998
E	5	C89x38x1.0	STUD	2398
F	1	C89x38x1.0	TOP TRACK	5000
G	1	C89x38x1.0	STUD	2398
Total Length: 41376.00mm				

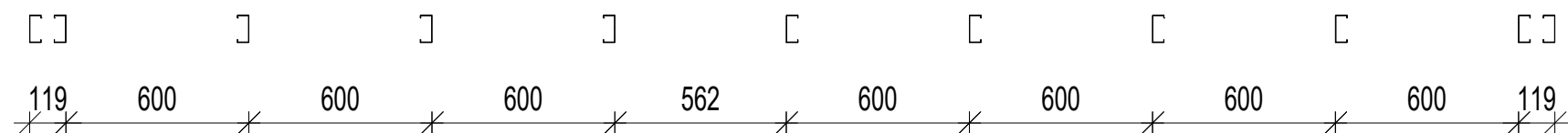
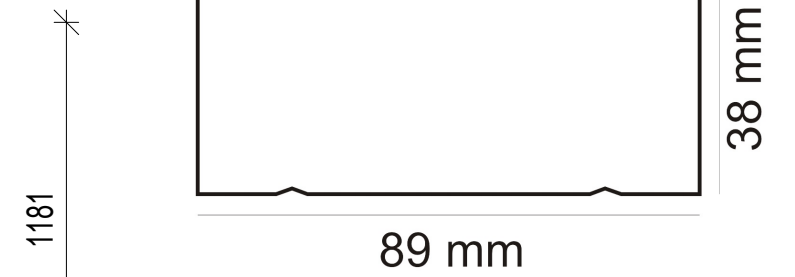
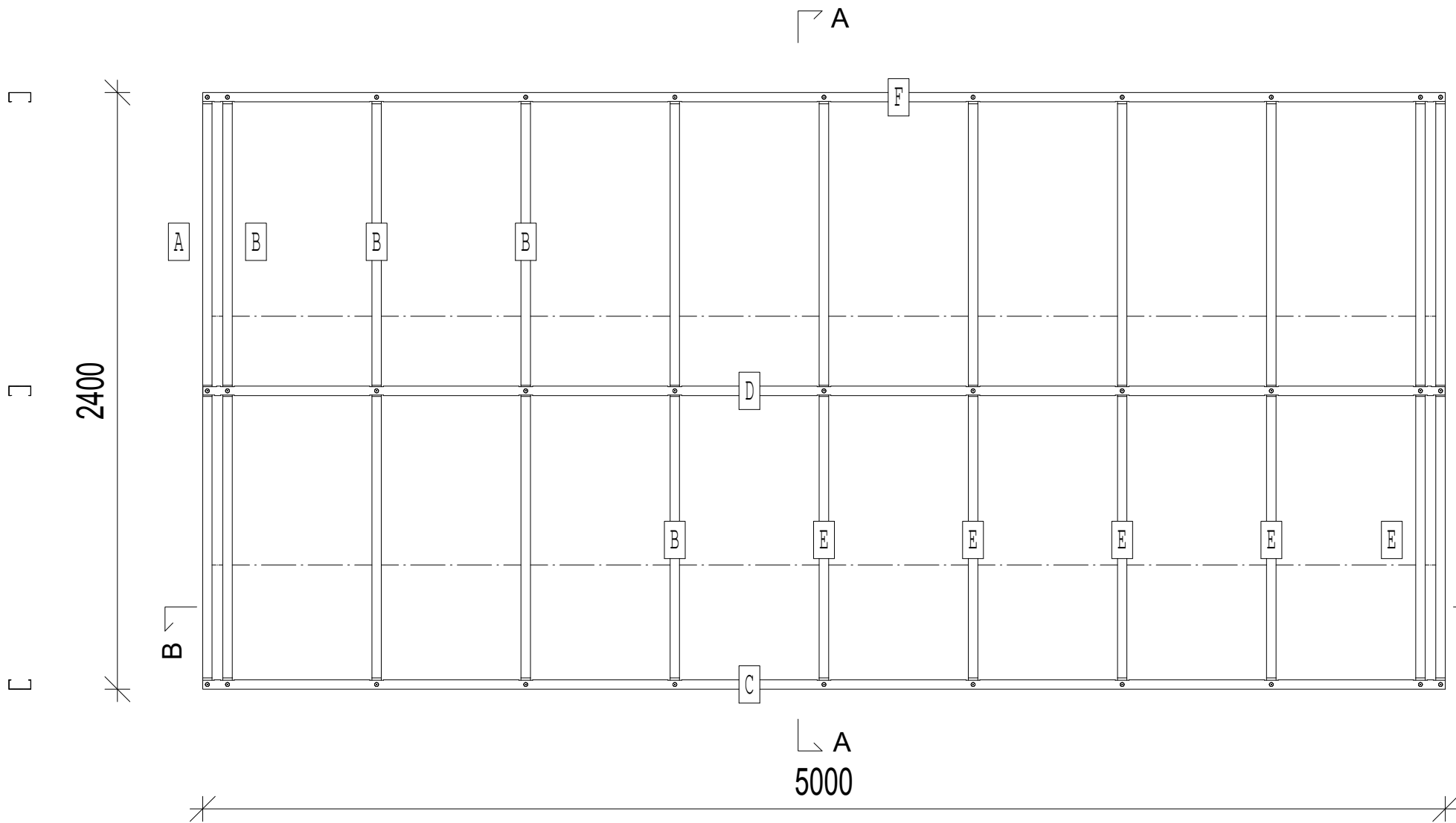

SCHEDULE				
PCE	QTY	MTRL	DESCRIPTION	LENGTH
A	1	C89x38x1.0	STUD	2398
B	4	C89x38x1.0	STUD	2398
C	1	C89x38x1.0	BOTTOM TRACK	6000
D	1	C89x38x1.0	NOGGIN	5998
E	5	C89x38x1.0	STUD	2398
F	1	C89x38x1.0	TOP TRACK	6000
G	1	C89x38x1.0	STUD	2398
Total Length: 44376.00mm				

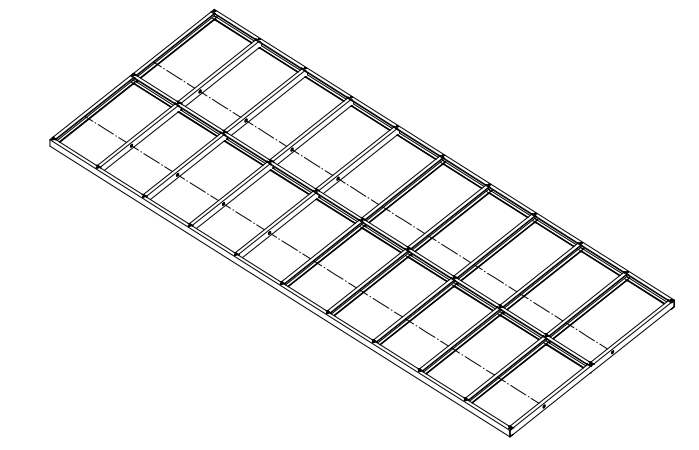
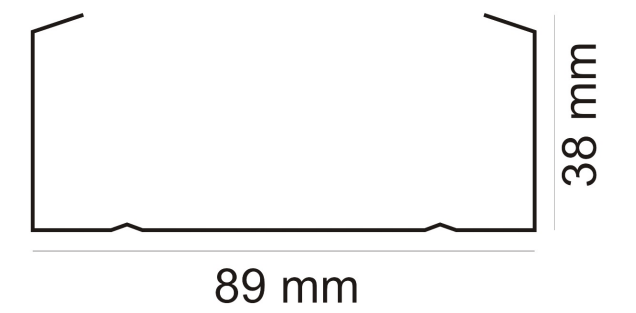
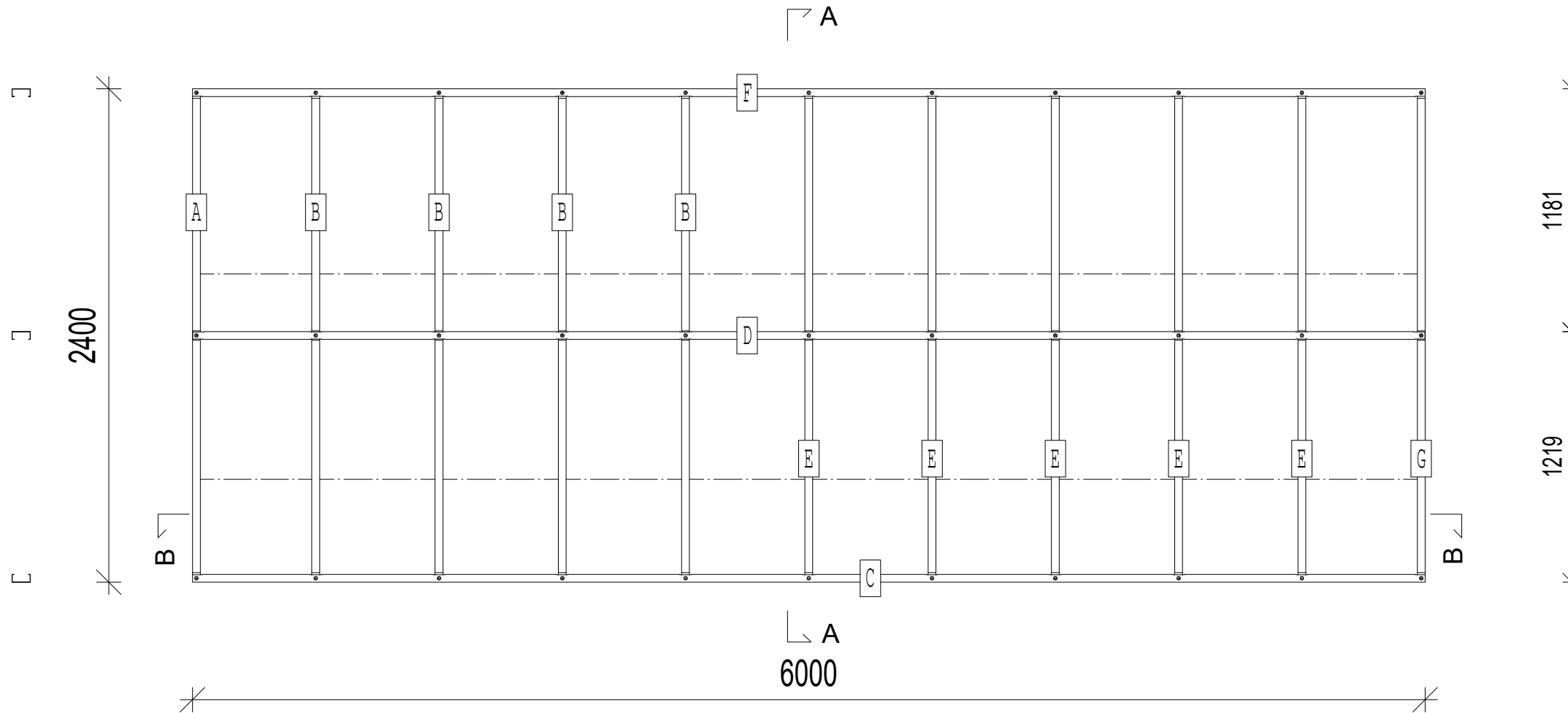

SCHEDULE				
PCE	QTY	MTRL	DESCRIPTION	LENGTH
A	1	C89x38x1.0	STUD	2398
B	6	C89x38x1.0	STUD	2398
C	1	C89x38x1.0	BOTTOM TRACK	6000
D	1	C89x38x1.0	NOGGIN	5998
E	7	C89x38x1.0	STUD	2398
F	1	C89x38x1.0	TOP TRACK	6000
G	1	C89x38x1.0	STUD	2398
Total Length: 53968.00mm				

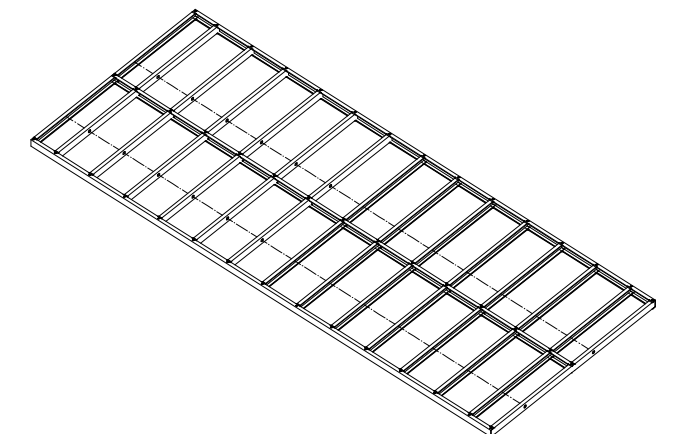
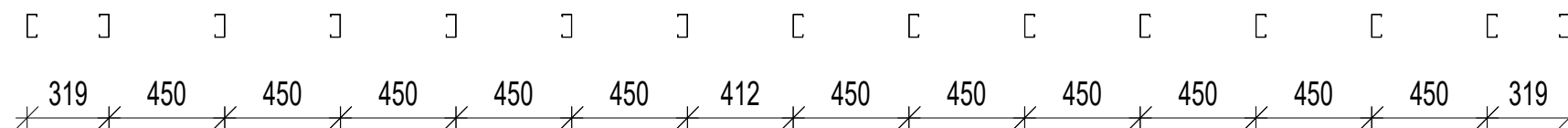
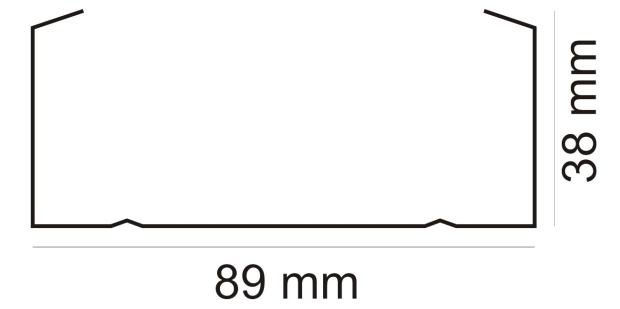
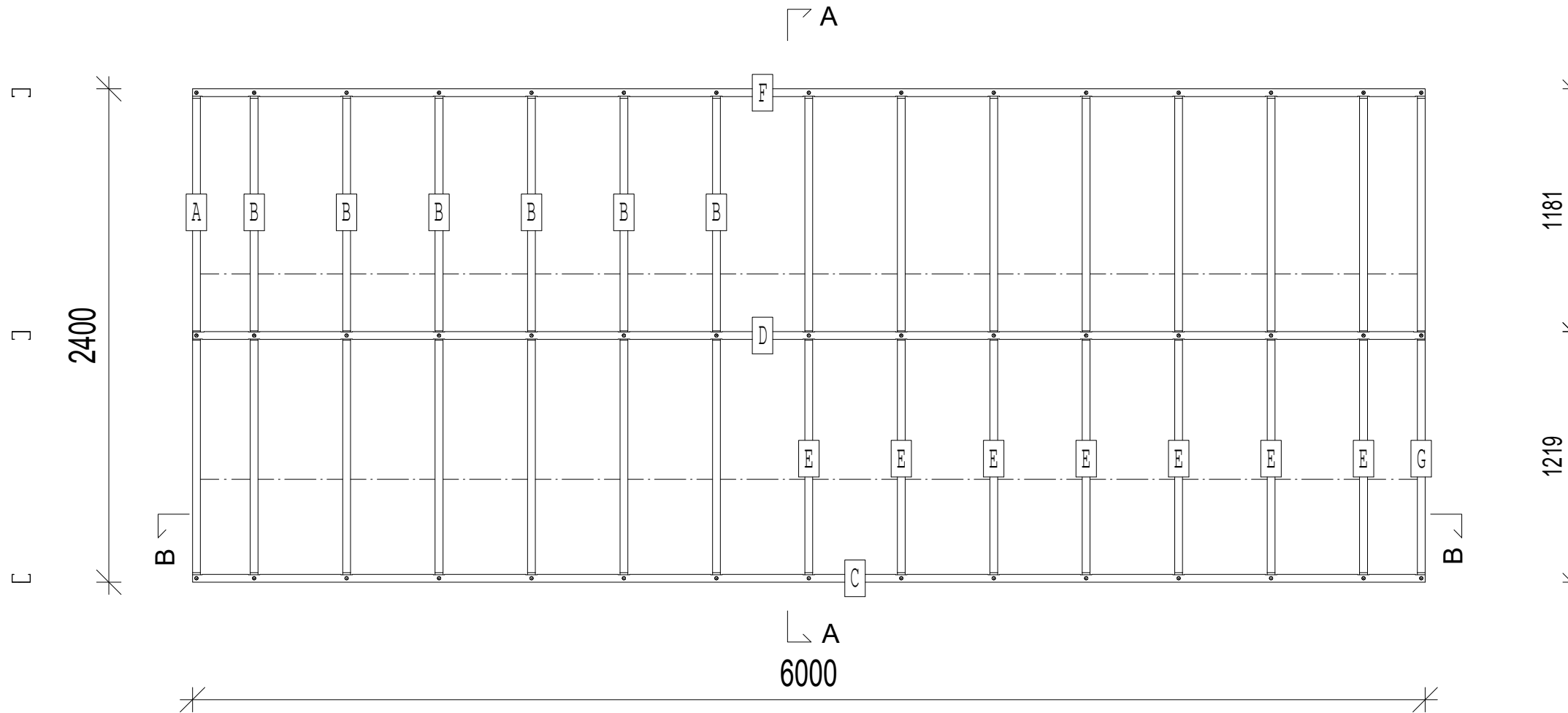

SCHEDULE				
PCE	QTY	MTRL	DESCRIPTION	LENGTH
A	1	C89x38x0.8	STUD	2398
B	6	C89x38x0.8	STUD	2398
C	1	C89x38x0.8	BOTTOM TRACK	6000
D	1	C89x38x0.8	NOGGIN	5998
E	7	C89x38x0.8	STUD	2398
F	1	C89x38x0.8	TOP TRACK	6000
G	1	C89x38x0.8	STUD	2398
Total Length: 53968.00mm				

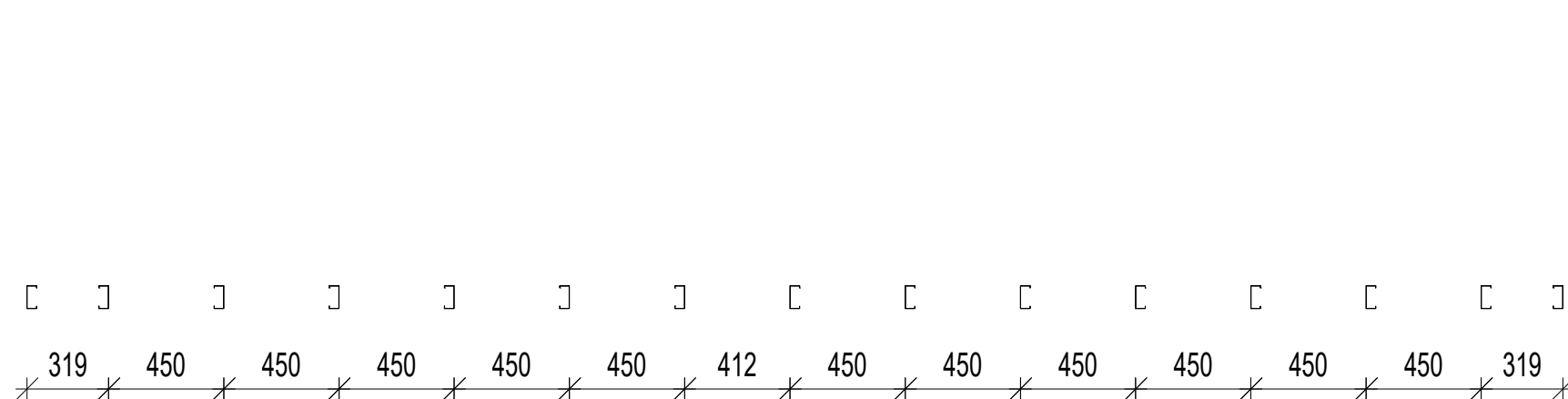
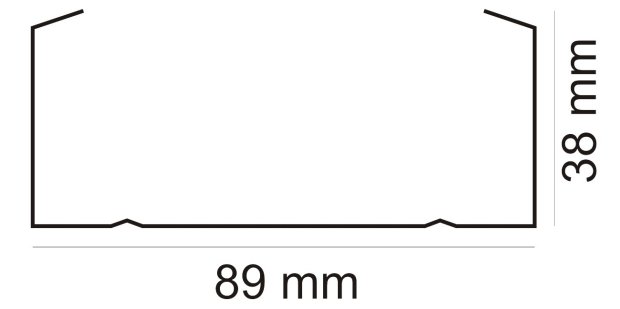
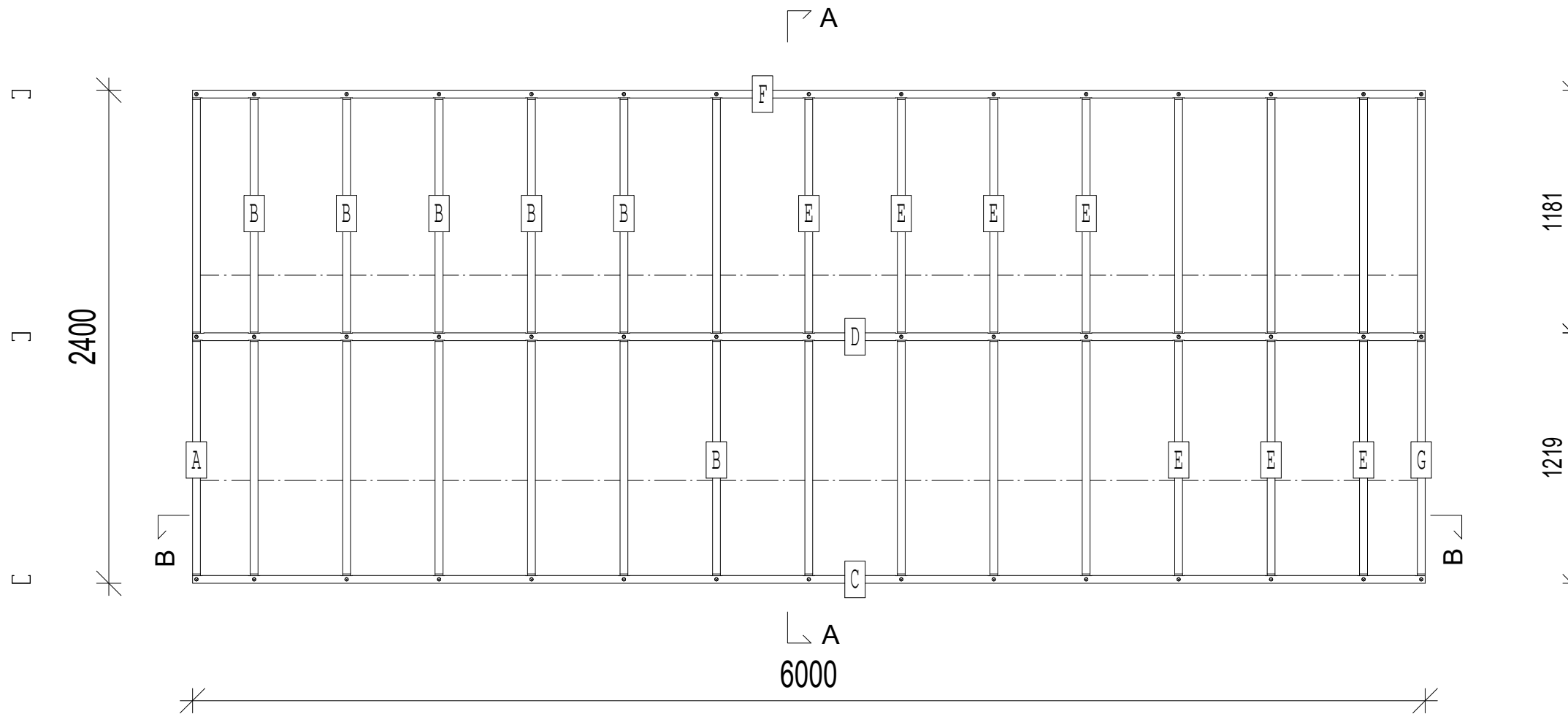

SCHEDULE				
PCE	QTY	MTRL	DESCRIPTION	LENGTH
A	1	C89x38x0.8	STUD	2398
B	4	C89x38x0.8	STUD	2398
C	1	C89x38x0.8	BOTTOM TRACK	6000
D	1	C89x38x0.8	NOGGIN	5998
E	5	C89x38x0.8	STUD	2398
F	1	C89x38x0.8	TOP TRACK	6000
G	1	C89x38x0.8	STUD	2398
Total Length: 44376.00mm				

